



**BEDRIJFSWAGEN-  
INRICHTINGEN**

**FITTINGS FOR  
COMMERCIAL VEHICLES**



**MERCEDES-BENZ SPRINTER**



## STOREVAN ORANGE PLANET - STOREVAN ORANGE PLANET

**STOREVAN ORANGE PLANET**

Duurzaamheid en ecologische ontwikkelingen zijn thema's van groot, actueel belang, ontstaan door het toenemende bewustzijn, dat het milieu door cyclische veranderingen en vernieuwingen in balans moet blijven.

**STOREVAN ORANGE PLANET**

Environmental sustainability and eco-compatible development are topics of great interest and relevance, arising from the growing awareness that it is important to pay attention to the environmental balance.

## CERTIFICERINGEN - CERTIFICATIONS

**GECERTIFICEERDE PRODUCTIE**

- ISO 9001:2008 zertifiziert.
- Succesvolle CRASH TEST volgens ECE-R17 met een snelheid van 50 Km/h.
- GS-Certificaat voor de laadplatforms en inrichtingen.
- GS-Certificaat voor imperiaal en ladderdrager.

**CERTIFIED PRODUCTION**

- ISO 9001:2008 certified.
- Brilliantly passed the CRASH TEST carried out according to the most recent European regulations ECE-R17 with impact at 50 Km/h.
- GS certification for interior fittings and loading ramps.
- GS certification for roof and ladder racks.



**StoreVan is wereldwijd de enige fabrikant van bedrijfswageninrichtingen, die met deze technologie werkt.**

**StoreVan is the sole LCV's equipment manufacturer worldwide to make use of this technology.**



#### **GEGALVANISEERD STAAL**

Het product wordt onder verhitting tot ca. 550 °C voorzien van een zinklaag. Daardoor ontstaat er een legering tussen blik en zink. Dat resulteert in een laag met een evenwichtige, fijne kristalstructuur en een **zeer hoge oppervlakte kwaliteit en corrosiebestendigheid**. Dit procedé is ideaal voor automotieve toepassingen. StoreVan heeft deze techniek nu ook voor haar bedrijfswageninrichtingen geïmplementeerd.

#### **HET PROCES VAN HET KATHODISCHE ACRYL DOMPELBAD VERFSYSTEEM**

De kathodische Acryl-afwerking is een oppervlakte behandeling, die de diverse onderdelen van de inrichting een **extrem hoge Corrosiebestendigheid** bezorgt. De dompelbad techniek garandeert een **gelijkmatige laagdikte** en een landurige bescherming tegen alle mogelijke stoffen. De Acrylhars beschermt de lak tegen uitbleken door weersinvloeden en is slagvast en daarmee blijvend corrosiebestendig.

- Corrosiebestendigheid meer dan 500 uur (ASTM D1735 Luchtvochtigheid)
- Uistekende hardheid met tenminste een rating van 2 H



#### **GALVANNEALED STEEL**

Galvannealed sheet is a variant of hot-dip galvanized sheet. The product is subject to a hot-dip-galvanization process and subsequently heated to approximately 550°C, combining the zinc with the sheet surface to make an alloy with iron. The result is a uniform zinc coating with a fine-grained crystalline structure along with a **much higher surface quality and corrosion resistance**. This process is ideal for automotive applications. StoreVan introduced and implemented this technology in the commercial vehicles equipment field.

#### **CATHODIC DIP PAINTING WITH ACRYLIC RESIN**

Cataphoresis painting is a paint surface treatment able to give the equipment elements a **remarkable resistance to corrosion**; characterized by **uniform deposit** of an acrylic resin on the element surface, it ensures long lasting and high protection against chemical agents and other types of surface attacks. The acrylic resin allows a direct exposure to atmospheric agents without altering its technical features. This process ensures an increased protection against rust.

- Corrosion resistance of more than 500 hours (humidity ASTM D1735)
- Excellent hardness with a minimum rating of 2H







# MERCEDES-BENZ SPRINTER

BESTELWAGEN - PANEL VAN

## BODEM- EN ZIJWANDBEKLEDING - FLOORING AND LININGS

- Bodemplaat en zijwandbekledingen voor een voertuig met rechter schuifdeur en stalen zijwanden.
- Flooring and linings for right side door vehicle with metal sheet sidewalls.

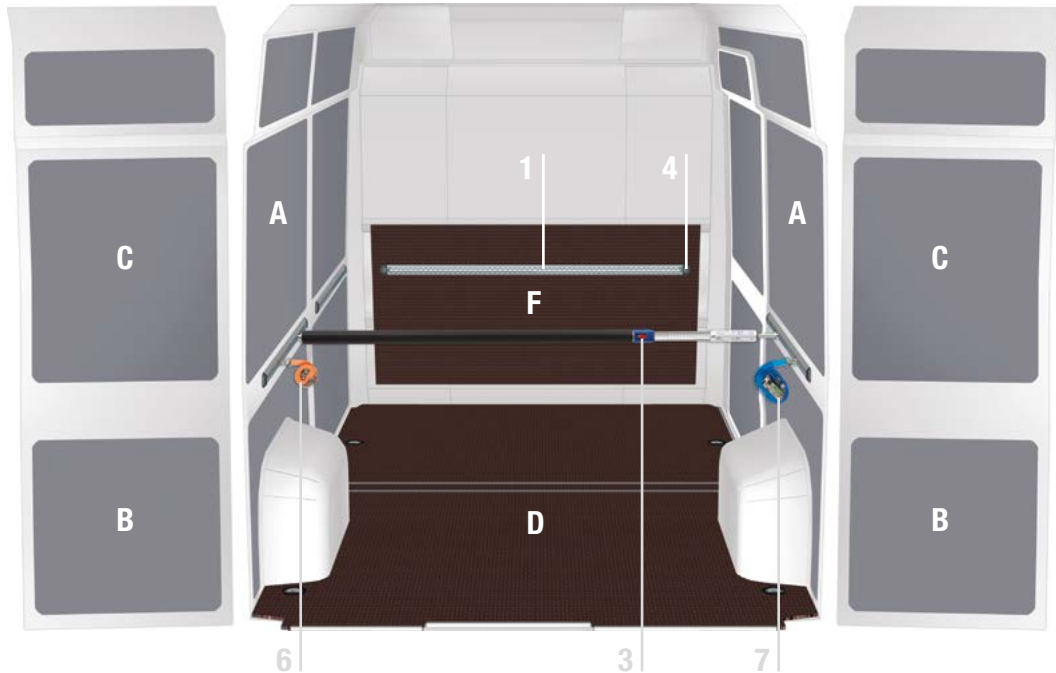

VOERTUIG VEHICLE	BODEMPLAAT 12 mm 12 mm FLOORING	WANDBEKLEDING LINING	WANDBEKLEDING LINING	CABINESCHOTPLAAT BULKHEAD
	D	A+B	C	F
	ART. NR. / ITEM NO.	ART. NR. / ITEM NO.	ART. NR. / ITEM NO.	ART. NR. / ITEM NO.
<b>Voertuigtype - Model</b> L1 H1 <sup>A</sup> Kort, Normaal Dak Short, Standard Roof	<b>PIL 107</b> 33,26 kg	<b>PAN 113</b> 13,61 kg	<b>PAR 107</b> 1,63 kg	<b>PIR 103</b> 8,95 kg
<b>Voertuigtype - Model</b> L1 H2 <sup>A</sup> Kort, Hoog Dak Short, High Roof	<b>PIL 107</b> 33,26 kg	<b>PAN 119</b> 16,11 kg	<b>PAR 108</b> 1,98 kg	<b>PIR 103</b> 8,95 kg
<b>Voertuigtype - Model</b> L2 H1 <sup>A</sup> Middellang, Normaal Dak Medium, Standard Roof	<b>PIL 108</b> 41,92 kg	<b>PAN 114</b> 16,71 kg	<b>PAR 107</b> 1,63 kg	<b>PIR 103</b> 8,95 kg
<b>Voertuigtype - Model</b> L2 H1 <sup>B</sup> Middellang, Normaal Dak Medium, Standard Roof	<b>PIL 109</b> 38,98 kg	<b>PAN 114</b> 16,71 kg	<b>PAR 107</b> 1,63 kg	<b>PIR 103</b> 8,95 kg
<b>Voertuigtype - Model</b> L2 H2 / H3 <sup>A</sup> Middellang, Hoog / Extra Hoog Dak Medium, High / Super-high Roof	<b>PIL 108</b> 41,92 kg	<b>PAN 115</b> 19,98 kg	<b>PAR 108</b> 1,98 kg	<b>PIR 103</b> 8,95 kg
<b>Voertuigtype - Model</b> L2 H2 / H3 <sup>B</sup> Middellang, Hoog / Extra Hoog Dak Medium, High / Super-high Roof	<b>PIL 109</b> 38,98 kg	<b>PAN 115</b> 19,98 kg	<b>PAR 108</b> 1,98 kg	<b>PIR 103</b> 8,95 kg
<b>Voertuigtype - Model</b> L3 H2 / H3 <sup>A</sup> Lang, Hoog / Extra Hoog Dak Long, High / Super-high Roof	<b>PIL 110</b> 57,12 kg	<b>PAN 116</b> 28,02 kg	<b>PAR 108</b> 1,98 kg	<b>PIR 103</b> 8,95 kg
<b>Voertuigtype - Model</b> L3 H2 / H3 <sup>B</sup> Lang, Hoog / Extra Hoog Dak Long, High / Super-high Roof	<b>PIL 111</b> 54,26 kg	<b>PAN 116</b> 28,02 kg	<b>PAR 108</b> 1,98 kg	<b>PIR 103</b> 8,95 kg
<b>Voertuigtype - Model</b> L3L H2 / H3 <sup>A</sup> Extralang, Hoog / Extra Hoog Dak Extra-long, High / Super-high Roof	<b>PIL 112</b> 62,92 kg	<b>PAN 117</b> 30,89 kg	<b>PAR 108</b> 1,98 kg	<b>PIR 103</b> 8,95 kg
<b>Voertuigtype - Model</b> L3L H2 / H3 <sup>B</sup> Extralang, Hoog / Extra Hoog Dak Extra-long, High / Super-high Roof	<b>PIL 113</b> 60,14 kg	<b>PAN 117</b> 30,89 kg	<b>PAR 108</b> 1,98 kg	<b>PIR 103</b> 8,95 kg

<sup>A</sup> Enkel lucht - Single wheels

<sup>B</sup> Dubbel lucht - Twin wheels

## BODEM- EN ZIJWANDBEKLEDING - FLOORING AND LININGS

**PAN**

- Wandbekleding uit polypropyleen voor:
  - linker zijwand
  - rechter zijwand en schuifdeur
  - onderste deel van de achterdeuren
- Polypropylene linings for:
  - LH sidewall
  - RH sidewall and sliding door
  - lower part of rear hinged doors

**PAR**

- Wandbekleding uit polypropyleen voor:
  - bovenste gedeelte van de achterdeuren
- Polypropylene linings for:
  - upper part of rear hinged doors

**PIL**

- Bodemplaat uit multiplex met phenolbekleding, dikte 12 mm, voorgeboord voor bevestiging met de bestaande sjoorogen.
- 12 mm thick wooden flooring with phenolic coating set for the vehicles original anchoring system

**PIR**

- Cabineshotplaat uit multiplex met phenolbekleding, dikte 12 mm
- 12 mm thick wooden bulkhead panel with phenolic coating

## LADING BEVESTIGING - LOAD SECURING

**BESCHRIJVING - DESCRIPTION**

- Horizontale Alurail.
- Horizontal aluminium bar.

ALURAIL - BAR	1	LENGTE - LENGTH
ART. NR. / ITEM NO. F 22 FC V18029 05 00		500 mm
ART. NR. / ITEM NO. F 22 FC V18029 10 00		1000 mm
ART. NR. / ITEM NO. F 22 FC V18029 15 00		1500 mm
ART. NR. / ITEM NO. F 22 FC V18029 20 00		2000 mm
ART. NR. / ITEM NO. F 22 FC V18029 25 00		2500 mm

**BESCHRIJVING - DESCRIPTION**

- Horizontale Alurails voor zijwanden.
- Horizontal aluminium bar for side panels.

ALURAIL - BAR	2	LENGTE - LENGTH
ART. NR. / ITEM NO. F 22 FC V18025 05 00		500 mm
ART. NR. / ITEM NO. F 22 FC V18025 10 00		1000 mm
ART. NR. / ITEM NO. F 22 FC V18025 15 00		1500 mm

**BESCHRIJVING - DESCRIPTION**

- Telescopische spanstang.
- Telescopic load restraining bar.

STANGEN - BAR	3	HOOGTE - HEIGHT
ART. NR. / ITEM NO. F 22 FC V22149 00 00		650-900 mm
ART. NR. / ITEM NO. F 22 FC V22131 00 00		1250-1750 mm
ART. NR. / ITEM NO. F 22 FC V22017 00 00		1550-2050 mm

**BESCHRIJVING - DESCRIPTION**

- Eindstop uit voor Alurail Serie V18029.
- Plastic end cap for bar series V18029.

EINDSTOP VOOR ALURAIL - PLASTIC END CAP FOR BAR	4
ART. NR. / ITEM NO. F 22 FC V22106 00 00	

**BESCHRIJVING - DESCRIPTION**

- Trekoog.
- Ring stud fitting.

TREKOOG - RING STUD FITTING	5
ART. NR. / ITEM NO. F 22 FC V22090 00 00	

**BESCHRIJVING - DESCRIPTION**

- Sjoorband met snapsluiting 2500+500.
- Load restraining belt with clamp 2500+500.

SJOBAND - BELT	6
ART. NR. / ITEM NO. F 22 FC V22136 00 00	

**BESCHRIJVING - DESCRIPTION**

- Sjoorband met ratel 2500+500.
- Load restraining belt with ratchet 2500+500.

SJOBAND - BELT	7
ART. NR. / ITEM NO. F 22 FC V22124 00 00	

Voor verdere informatie kunt u onze catalogus "Load Securing" raadplegen

For more information, ask for our "Load Securing" catalogue



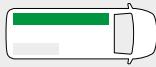

## INRICHTINGSVOORBEELDEN - FITTINGS EXAMPLES

**VOORBEELD - EXAMPLE**
**SP 2215 01\***

B=2241 D=365 H=1540 mm - W=2241 D=365 H=1540 mm

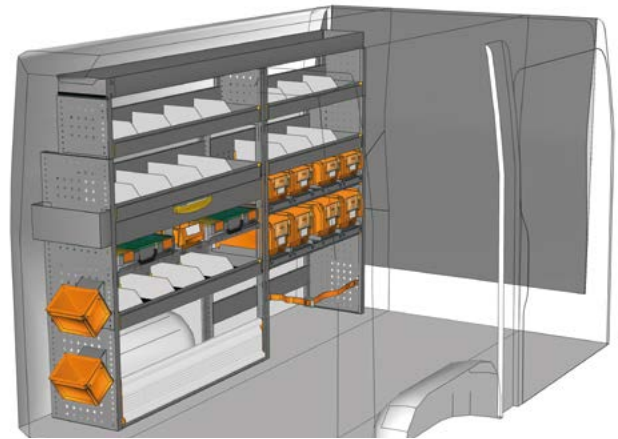
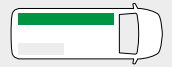
**VOORBEELD - EXAMPLE**
**SP 2215 02\***

B=2241 D=365 H=1540 mm - W=2241 D=365 H=1540 mm

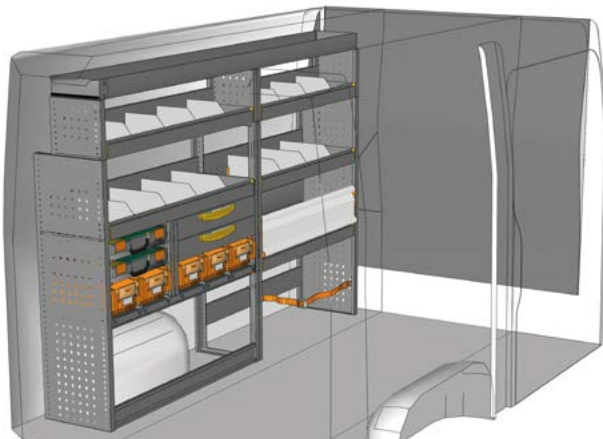
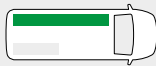
**VOORBEELD - EXAMPLE**
**SP 2215 03\***

B=2241 D=365 H=1540 mm - W=2241 D=365 H=1540 mm

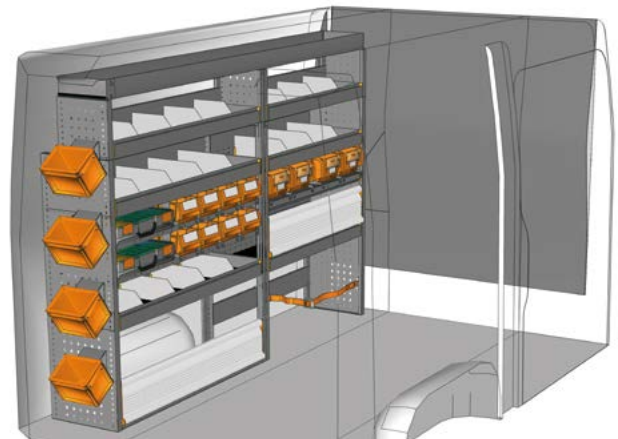
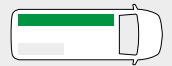
**VOORBEELD - EXAMPLE**
**SP 2215 04\***

B=2241 D=365 H=1540 mm - W=2241 D=365 H=1540 mm

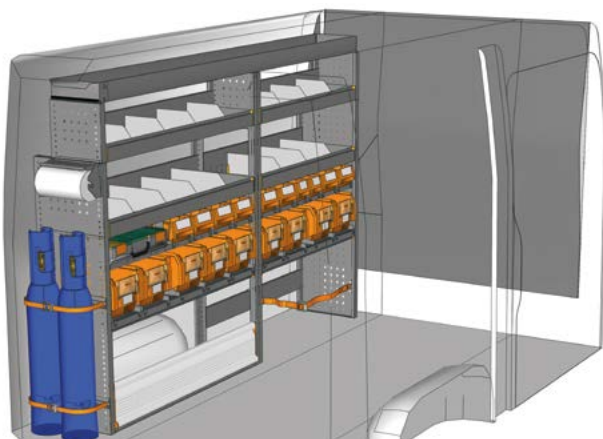
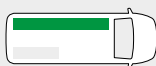
**VOORBEELD - EXAMPLE**
**SP 2215 05\***

B=2241 D=365 H=1540 mm - W=2241 D=365 H=1540 mm

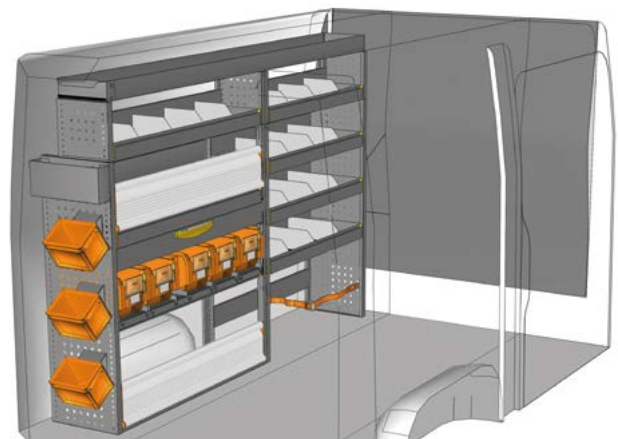
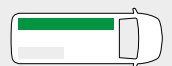

**VOORBEELD - EXAMPLE**
**SP 2215 06\***

B=2241 D=365 H=1540 mm - W=2241 D=365 H=1540 mm



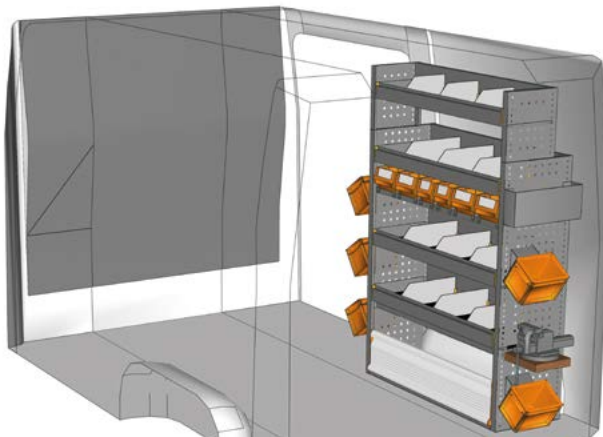

INRICHTINGSVOORBEELDEN - FITTINGS EXAMPLES



VOORBEELD - EXAMPLE

SP 1015 01\*

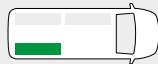

B=1016 D=365 H=1500 mm - W=1016 D=365 H=1500 mm

**Heeft u uw ideale inrichting niet gevonden?  
Dan wendt u zich aan onze vakmensen voor  
bedrijfswageninrichtingen.**

Op de achterzijde vindt u de  
adresgegevens of bezoek onze  
website [www.storevannederland.nl](http://www.storevannederland.nl)



**Didn't find the equipment  
you're looking for?  
Leave it to our experts.**

See the back of this catalogue  
and contact the nearest  
StoreVan point or visit our website.

**\* Inclusief bevestigingsmateriaal - Fixing kit included**

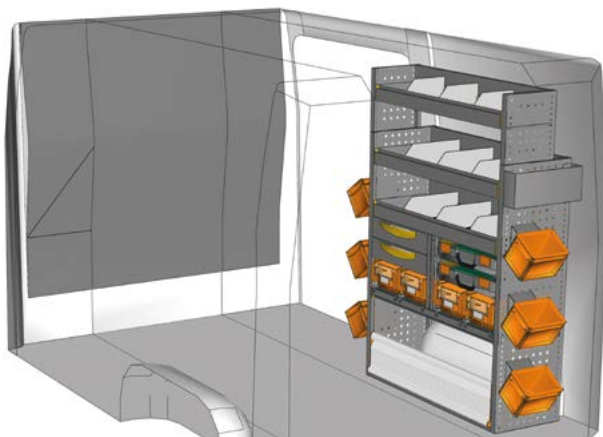

VOORBEELD - EXAMPLE

SP 1015 02\*



B=1016 D=365 H=1500 mm - W=1016 D=365 H=1500 mm

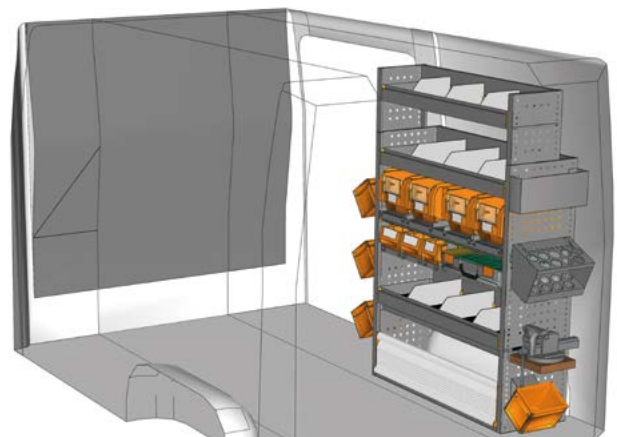

VOORBEELD - EXAMPLE

SP 1015 03\*

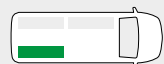

B=1016 D=365 H=1500 mm - W=1016 D=365 H=1500 mm

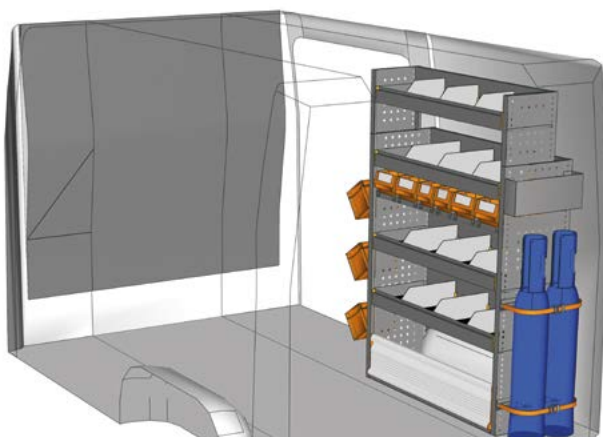

VOORBEELD - EXAMPLE

SP 1015 04\*



B=1016 D=365 H=1500 mm - W=1016 D=365 H=1500 mm

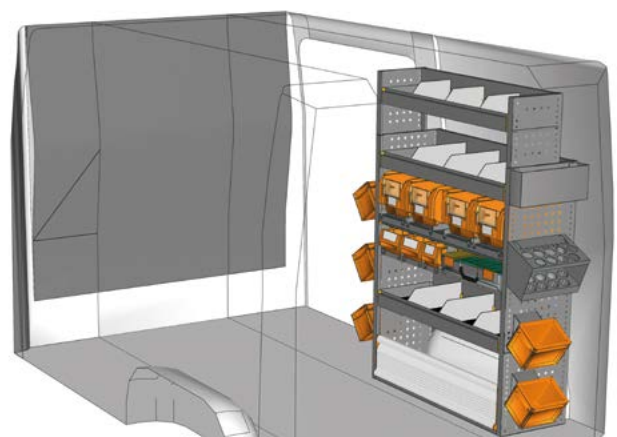

VOORBEELD - EXAMPLE

SP 1015 05\*



B=1016 D=365 H=1500 mm - W=1016 D=365 H=1500 mm

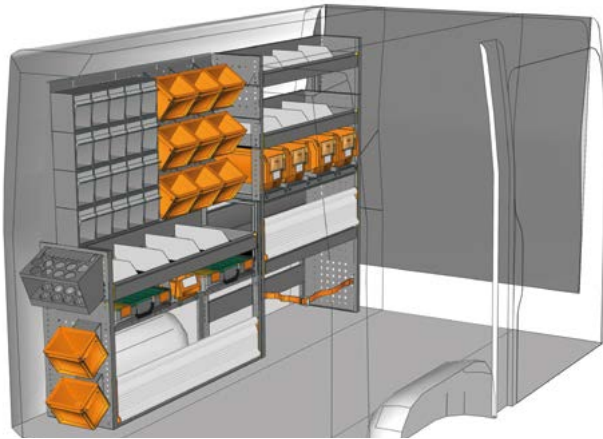

## INRICHTINGSVOORBEELDEN - FITTINGS EXAMPLES

**VOORBEELD - EXAMPLE**
**SP 2215 07\***

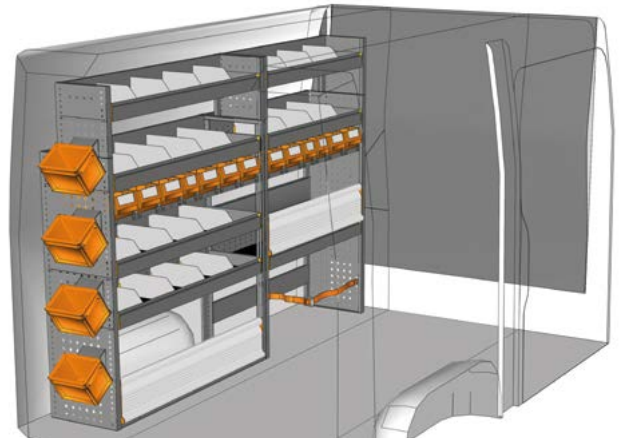

B=2241 D=365 H=1500 mm - W=2241 D=365 H=1500 mm

**VOORBEELD - EXAMPLE**
**SP 2215 08\***

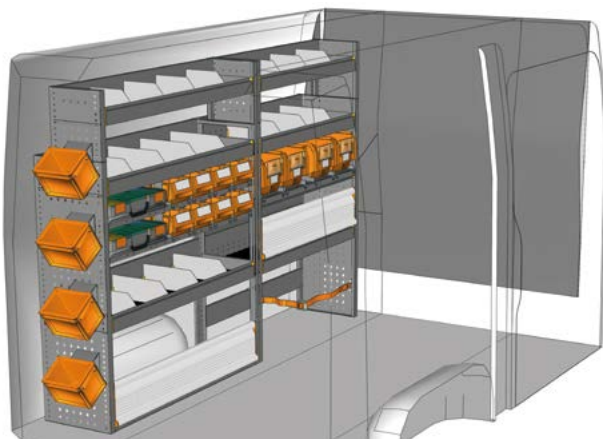
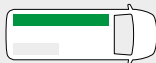

B=2241 D=365 H=1500 mm - W=2241 D=365 H=1500 mm

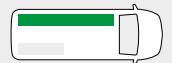
**VOORBEELD - EXAMPLE**
**SP 2215 09\***

B=2241 D=365 H=1500 mm - W=2241 D=365 H=1500 mm

**VOORBEELD - EXAMPLE**
**SP 2215 10\***

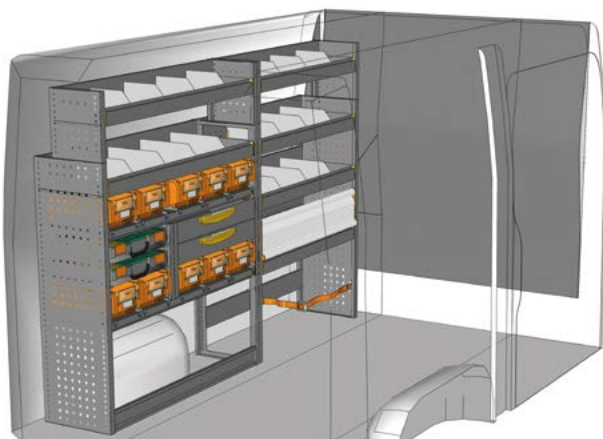
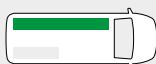
B=2241 D=365 H=1500 mm - W=2241 D=365 H=1500 mm

**VOORBEELD - EXAMPLE**
**SP 2215 11\***

B=2241 D=365 H=1500 mm - W=2241 D=365 H=1500 mm

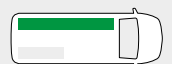
**VOORBEELD - EXAMPLE**
**SP 2215 12\***

B=2241 D=365 H=1500 mm - W=2241 D=365 H=1500 mm



INRICHTINGSVOORBEELDEN - FITTINGS EXAMPLES

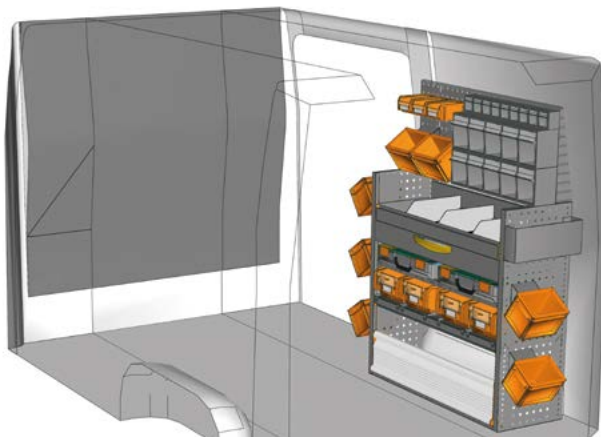

VOORBEELD - EXAMPLE

SP 1015 07\*

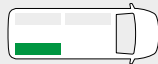

B=1016 D=365 H=1420 mm - W=1016 D=365 H=1420 mm

**Heeft u uw ideale inrichting niet gevonden?  
Dan wendt u zich aan onze vakmensen voor  
bedrijfswageninrichtingen.**

Op de achterzijde vindt u de  
adresgegevens of bezoek onze  
website [www.storevannederland.nl](http://www.storevannederland.nl)



**Didn't find the equipment  
you're looking for?  
Leave it to our experts.**

See the back of this catalogue  
and contact the nearest  
StoreVan point or visit our website.

**\* Inclusief bevestigingsmateriaal - Fixing kit included**

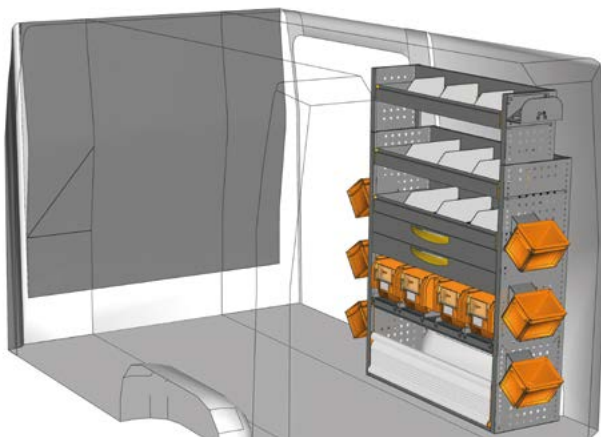

VOORBEELD - EXAMPLE

SP 1015 08\*



B=1016 D=365 H=1500 mm - W=1016 D=365 H=1500 mm

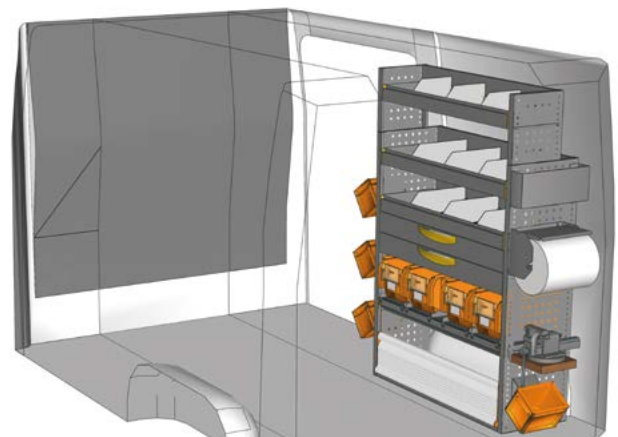

VOORBEELD - EXAMPLE

SP 1015 09\*

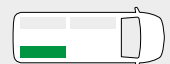

B=1016 D=365 H=1500 mm - W=1016 D=365 H=1500 mm

Aanzicht vanuit de schuifdeur  
View from side door

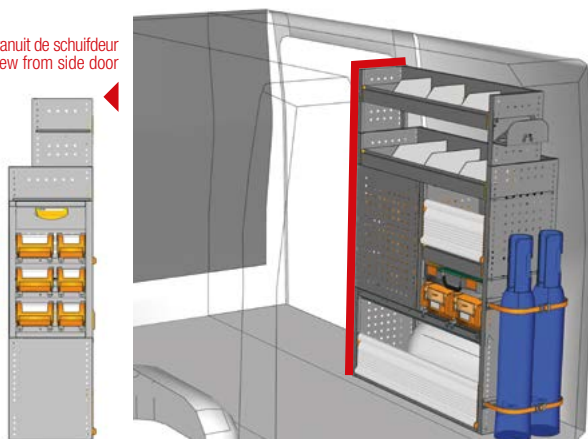

VOORBEELD - EXAMPLE

SP 1015 11\*



B=1016 D=365 H=1500 mm - W=1016 D=365 H=1500 mm

Aanzicht vanuit de schuifdeur  
View from side door

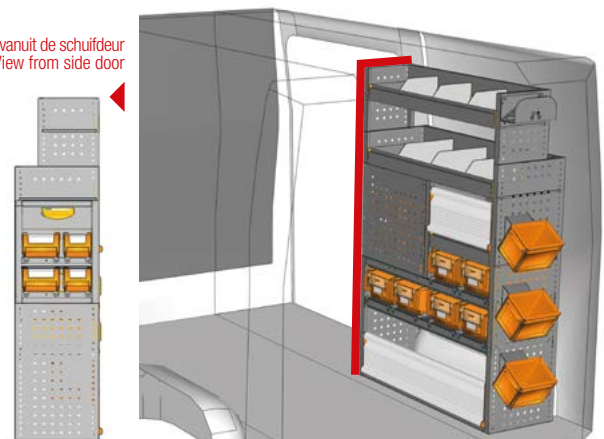

VOORBEELD - EXAMPLE

SP 1015 12\*



B=1016 D=365 H=1500 mm - W=1016 D=365 H=1500 mm



INRICHTINGSVOORBEELDEN - FITTINGS EXAMPLES



VOORBEELD - EXAMPLE

SP 2715 01\*

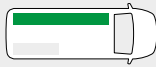

B=2749 D=365 H=1540 mm - W=2749 D=365 H=1540 mm



VOORBEELD - EXAMPLE

SP 2715 02\*

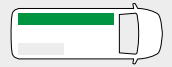

B=2749 D=365 H=1540 mm - W=2749 D=365 H=1540 mm



VOORBEELD - EXAMPLE

SP 2715 03\*

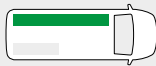

B=2749 D=365 H=1540 mm - W=2749 D=365 H=1540 mm



VOORBEELD - EXAMPLE

SP 2715 04\*

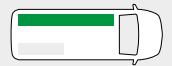

B=2749 D=365 H=1540 mm - W=2749 D=365 H=1540 mm



VOORBEELD - EXAMPLE

SP 2715 05\*

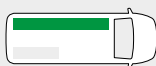

B=2749 D=365 H=1540 mm - W=2749 D=365 H=1540 mm



VOORBEELD - EXAMPLE

SP 2715 06\*

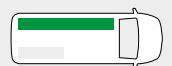

B=2749 D=365 H=1540 mm - W=2749 D=365 H=1540 mm



INRICHTINGSVOORBEELDEN - FITTINGS EXAMPLES

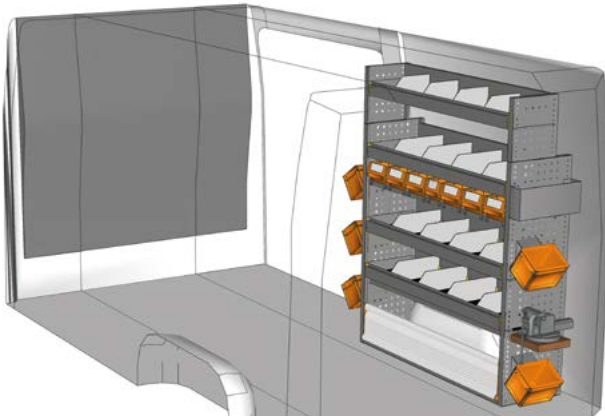

VOORBEELD - EXAMPLE

SP 1215 01\*

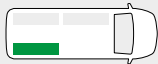

B=1225 D=365 H=1500 mm - W=1225 D=365 H=1500 mm

**Heeft u uw ideale inrichting niet gevonden?  
Dan wendt u zich aan onze vakmensen voor  
bedrijfswageninrichtingen.**

Op de achterzijde vindt u de  
adresgegevens of bezoek onze  
website [www.storevannederland.nl](http://www.storevannederland.nl)



**Didn't find the equipment  
you're looking for?  
Leave it to our experts.**

See the back of this catalogue  
and contact the nearest  
StoreVan point or visit our website.

**\* Inclusief bevestigingsmateriaal - Fixing kit included**

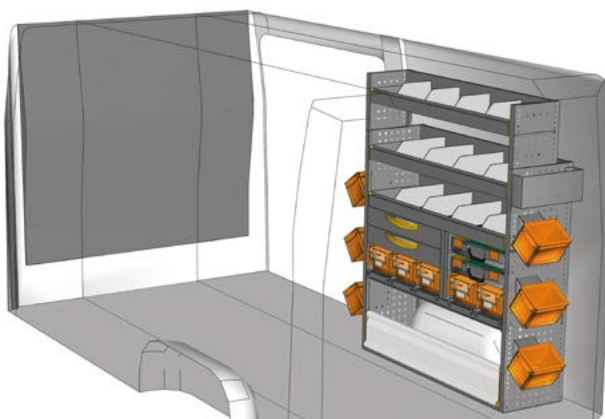

VOORBEELD - EXAMPLE

SP 1215 02\*



B=1225 D=365 H=1500 mm - W=1225 D=365 H=1500 mm

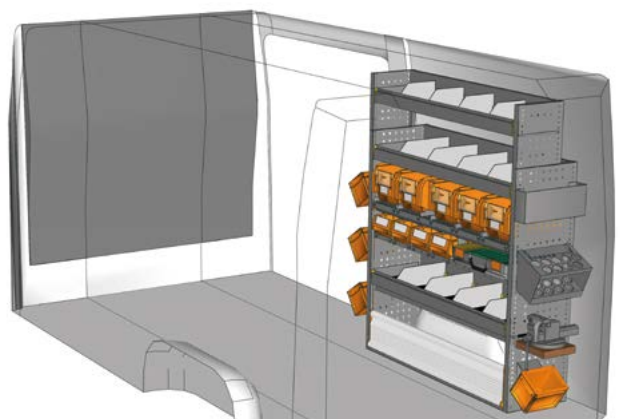

VOORBEELD - EXAMPLE

SP 1215 03\*

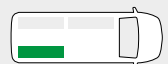

B=1225 D=365 H=1500 mm - W=1225 D=365 H=1500 mm

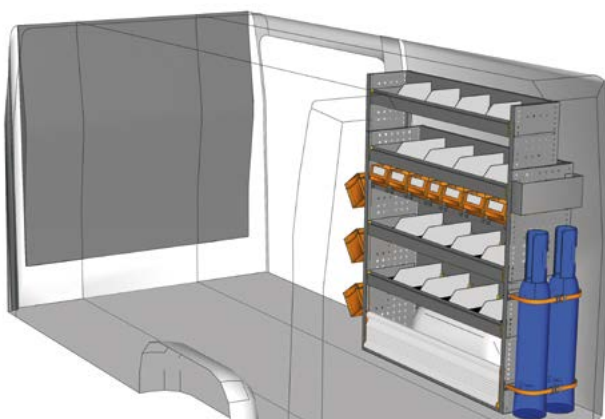

VOORBEELD - EXAMPLE

SP 1215 04\*



B=1225 D=365 H=1500 mm - W=1225 D=365 H=1500 mm

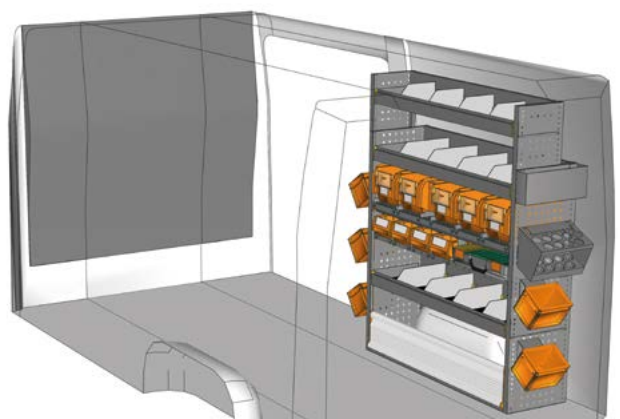

VOORBEELD - EXAMPLE

SP 1215 05\*



B=1225 D=365 H=1500 mm - W=1225 D=365 H=1500 mm

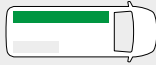

## INRICHTINGSVOORBEELDEN - FITTINGS EXAMPLES

**VOORBEELD - EXAMPLE**
**SP 2715 07\***

B=2749 D=365 H=1500 mm - W=2749 D=365 H=1500 mm

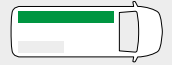
**VOORBEELD - EXAMPLE**
**SP 2715 08\***

B=2749 D=365 H=1500 mm - W=2749 D=365 H=1500 mm

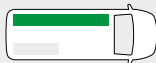
**VOORBEELD - EXAMPLE**
**SP 2715 09\***

B=2749 D=365 H=1500 mm - W=2749 D=365 H=1500 mm

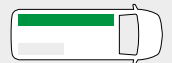
**VOORBEELD - EXAMPLE**
**SP 2715 10\***

B=2749 D=365 H=1500 mm - W=2749 D=365 H=1500 mm

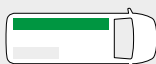
**VOORBEELD - EXAMPLE**
**SP 2715 11\***

B=2749 D=365 H=1500 mm - W=2749 D=365 H=1500 mm

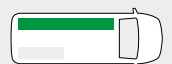
**VOORBEELD - EXAMPLE**
**SP 2715 12\***

B=2749 D=365 H=1500 mm - W=2749 D=365 H=1500 mm



INRICHTINGSVOORBEELDEN - FITTINGS EXAMPLES

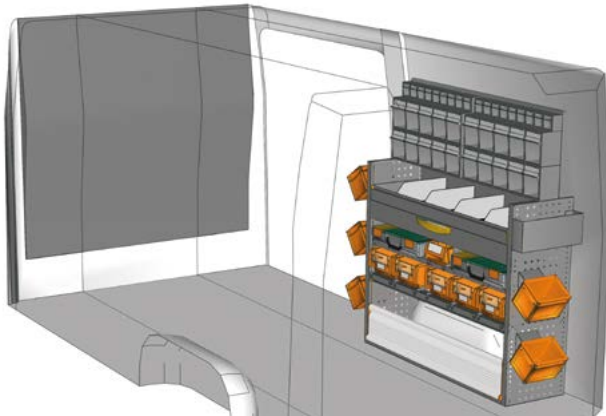

VOORBEELD - EXAMPLE

SP 1215 07\*

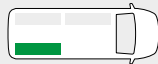

B=1225 D=365 H=1420 mm - W=1225 D=365 H=1420 mm

**Heeft u uw ideale inrichting niet gevonden?  
Dan wendt u zich aan onze vakmensen voor  
bedrijfswageninrichtingen.**

Op de achterzijde vindt u de  
adresgegevens of bezoek onze  
website [www.storevannederland.nl](http://www.storevannederland.nl)



**Didn't find the equipment  
you're looking for?  
Leave it to our experts.**

See the back of this catalogue  
and contact the nearest  
StoreVan point or visit our website.

**\* Inclusief bevestigingsmateriaal - Fixing kit included**



VOORBEELD - EXAMPLE

SP 1215 08\*



B=1225 D=365 H=1500 mm - W=1225 D=365 H=1500 mm



VOORBEELD - EXAMPLE

SP 1215 09\*



B=1225 D=365 H=1500 mm - W=1225 D=365 H=1500 mm

Aanzicht vanuit de schuifdeur  
View from side door

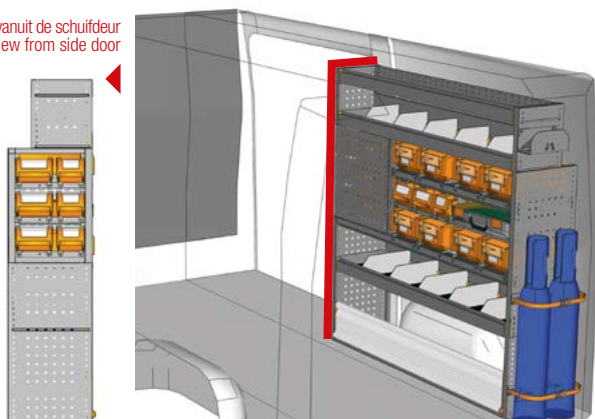

VOORBEELD - EXAMPLE

SP 1515 01\*



B=1524 D=365 H=1500 mm - W=1524 D=365 H=1500 mm

Aanzicht vanuit de schuifdeur  
View from side door

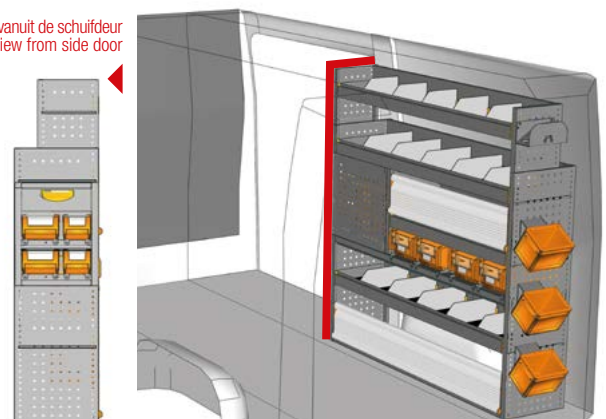

VOORBEELD - EXAMPLE

SP 1515 02\*



B=1524 D=365 H=1500 mm - W=1524 D=365 H=1500 mm

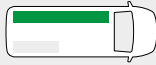

**INRICHTINGSVOORBEELDEN - FITTINGS EXAMPLES**

**VOORBEELD - EXAMPLE**
**SP 2717 01\***

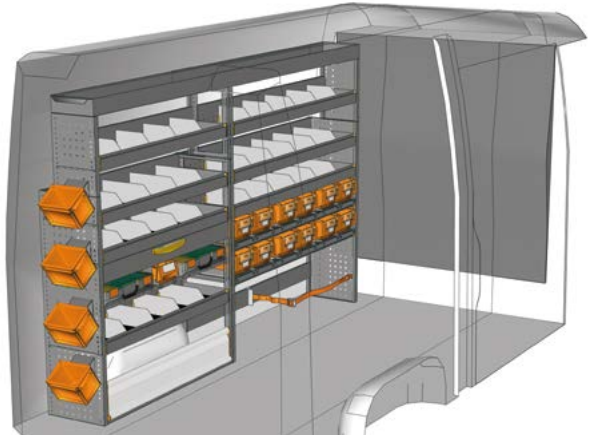
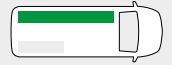
B=2749 D=365 H=1690 mm - W=2749 D=365 H=1690 mm

**VOORBEELD - EXAMPLE**
**SP 2717 02\***

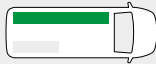
B=2749 D=365 H=1690 mm - W=2749 D=365 H=1690 mm

**VOORBEELD - EXAMPLE**
**SP 2717 03\***

B=2749 D=365 H=1690 mm - W=2749 D=365 H=1690 mm

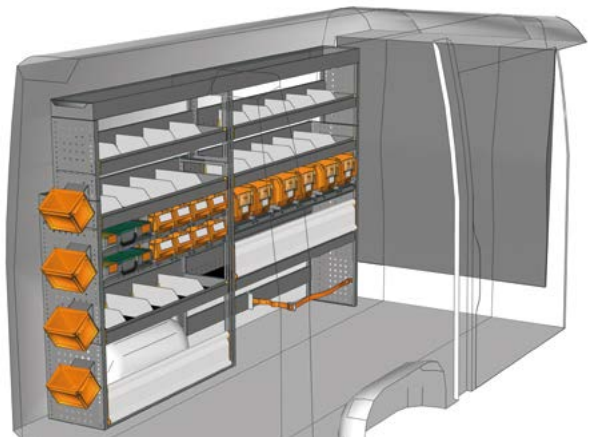
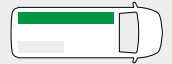
**VOORBEELD - EXAMPLE**
**SP 2717 04\***

B=2749 D=365 H=1690 mm - W=2749 D=365 H=1690 mm

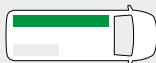
**VOORBEELD - EXAMPLE**
**SP 2717 05\***

B=2749 D=365 H=1690 mm - W=2749 D=365 H=1690 mm

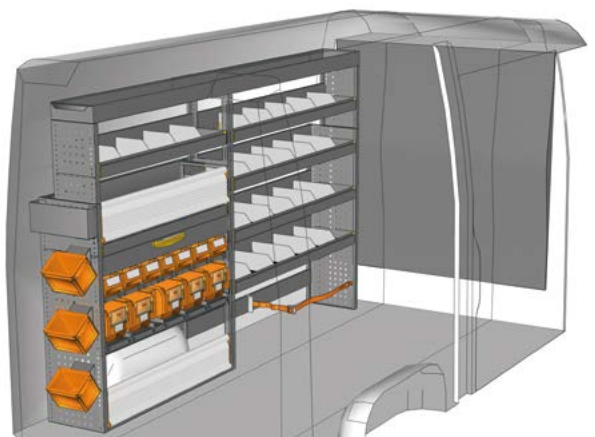
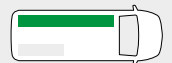
**VOORBEELD - EXAMPLE**
**SP 2717 06\***

B=2749 D=365 H=1690 mm - W=2749 D=365 H=1690 mm





INRICHTINGSVOORBEELDEN - FITTINGS EXAMPLES



VOORBEELD - EXAMPLE

SP 1217 01\*

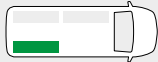

B=1225 D=365 H=1700 mm - W=1225 D=365 H=1700 mm

**Heeft u uw ideale inrichting niet gevonden?  
Dan wendt u zich aan onze vakmensen voor  
bedrijfswageninrichtingen.**

Op de achterzijde vindt u de  
adresgegevens of bezoek onze  
website [www.storevannederland.nl](http://www.storevannederland.nl)



**Didn't find the equipment  
you're looking for?  
Leave it to our experts.**

See the back of this catalogue  
and contact the nearest  
StoreVan point or visit our website.

**\* Inclusief bevestigingsmateriaal - Fixing kit included**



VOORBEELD - EXAMPLE

SP 1217 02\*

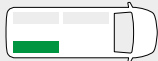

B=1225 D=365 H=1700 mm - W=1225 D=365 H=1700 mm

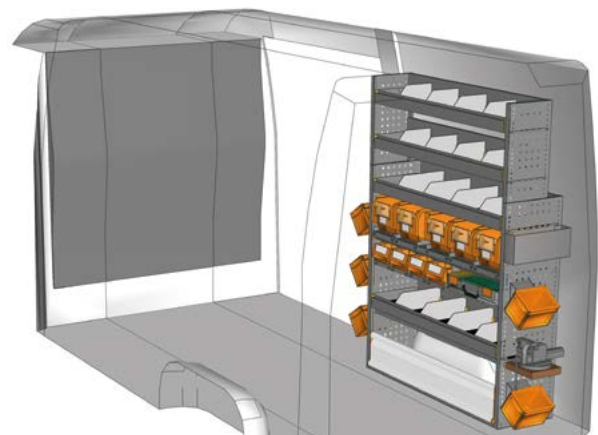

VOORBEELD - EXAMPLE

SP 1217 03\*

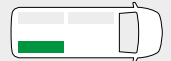

B=1225 D=365 H=1700 mm - W=1225 D=365 H=1700 mm



VOORBEELD - EXAMPLE

SP 1217 04\*

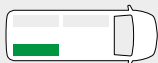

B=1225 D=365 H=1700 mm - W=1225 D=365 H=1700 mm

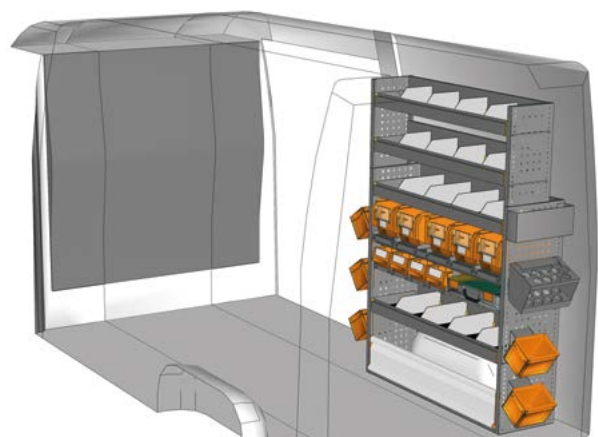

VOORBEELD - EXAMPLE

SP 1217 05\*



B=1225 D=365 H=1700 mm - W=1225 D=365 H=1700 mm

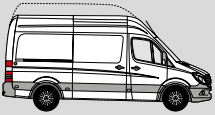

INRICHTINGSVOORBEELDEN - FITTINGS EXAMPLES



VOORBEELD - EXAMPLE

SP 2717 07\*

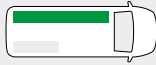

B=2749 D=365 H=1700 mm - W=2749 D=365 H=1700 mm

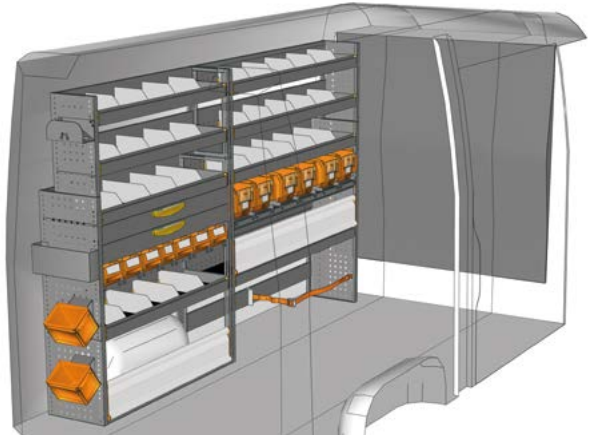

VOORBEELD - EXAMPLE

SP 2717 08\*



B=2749 D=365 H=1700 mm - W=2749 D=365 H=1700 mm



VOORBEELD - EXAMPLE

SP 2717 09\*



B=2749 D=365 H=1700 mm - W=2749 D=365 H=1700 mm



VOORBEELD - EXAMPLE

SP 2717 10\*



B=2749 D=365 H=1700 mm - W=2749 D=365 H=1700 mm



VOORBEELD - EXAMPLE

SP 2717 11\*

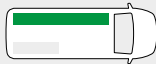

B=2749 D=365 H=1700 mm - W=2749 D=365 H=1700 mm



VOORBEELD - EXAMPLE

SP 2717 12\*

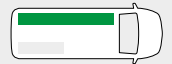

B=2749 D=365 H=1700 mm - W=2749 D=365 H=1700 mm



INRICHTINGSVOORBEELDEN - FITTINGS EXAMPLES

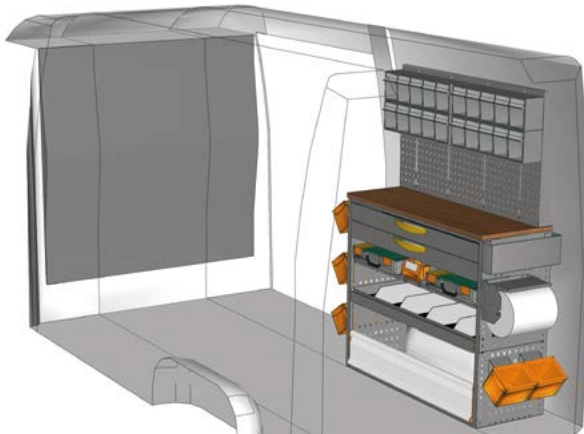

VOORBEELD - EXAMPLE

SP 1217 07\*

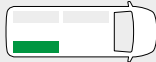

B=1225 D=445 H=1725 mm - W=1225 D=445 H=1725 mm

**Heeft u uw ideale inrichting niet gevonden?  
Dan wendt u zich aan onze vakmensen voor  
bedrijfswageninrichtingen.**

Op de achterzijde vindt u de  
adresgegevens of bezoek onze  
website [www.storevannederland.nl](http://www.storevannederland.nl)



**Didn't find the equipment  
you're looking for?  
Leave it to our experts.**

See the back of this catalogue  
and contact the nearest  
StoreVan point or visit our website.

**\* Inclusief bevestigingsmateriaal - Fixing kit included**



VOORBEELD - EXAMPLE

SP 1217 08\*

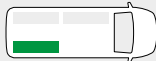

B=1225 D=365 H=1700 mm - W=1225 D=365 H=1700 mm



VOORBEELD - EXAMPLE

SP 1217 09\*

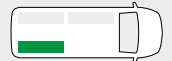

B=1225 D=365 H=1700 mm - W=1225 D=365 H=1700 mm

Aanzicht vanuit de schuifdeur  
View from side door

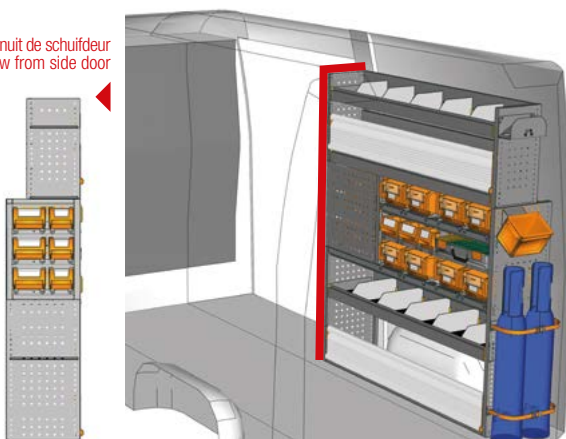

VOORBEELD - EXAMPLE

SP 1517 01\*



B=1524 D=365 H=1700 mm - W=1524 D=365 H=1700 mm

Aanzicht vanuit de schuifdeur  
View from side door

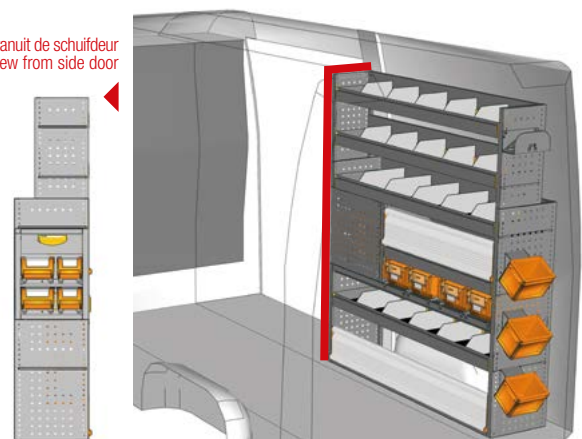

VOORBEELD - EXAMPLE

SP 1517 02\*



B=1524 D=365 H=1700 mm - W=1524 D=365 H=1700 mm



# MERCEDES-BENZ SPRINTER

BESTELWAGEN - PANEL VAN

## IMPERIAALS EN LADDERDRAGERS - ROOF AND LADDER RACK



VOERTUIG VEHICLE	IMPERIAAL ROOF RACK	AFMETINGEN DIMENSIONS	GEWICHT WEIGHT	DRAAGVERMOGEN LOAD CAPACITY
	<b>ART. NR. / ITEM NO.</b>			
<b>Voertuigtype - Model</b> L1 H1 Kort, Normaal Dak Short, Standard Roof	<b>POT 107</b>	2750x1700 mm	29,84 kg	170,00 kg
<b>Voertuigtype - Model</b> L1 H2 Kort, Hoog Dak Short, High Roof	<b>POT 113</b>	2750x1700 mm	29,84 kg	120,00 kg
<b>Voertuigtype - Model</b> L2 H1 Middellang, Normaal Dak Medium, Standard Roof	<b>POT 108</b>	3400x1700 mm	32,26 kg	167,00 kg
<b>Voertuigtype - Model</b> L2 H2 Middellang, Hoog Dak Medium, High Roof	<b>POT 109</b>	3400x1700 mm	32,26 kg	117,00 kg
<b>Voertuigtype - Model</b> L3 H2 Lang, Hoog Dak Long, High Roof	<b>POT 110</b>	4350x1700 mm	39,68 kg	110,00 kg
<b>Voertuigtype - Model</b> L3L H2 Extralang, Hoog Dak Extra-long, High Roof	<b>POT 111</b>	4700x1700 mm	44,76 kg	105,00 kg

### POT

- Imperiaal bestaande uit:
  - Alu-dwarsdragers inclusief bevestigingen en rubber profielen
  - Aluminium zijkanten
  - Aluminium laadrol
  - RVS bevestigingsmateriaal

- Roof rack complete of:
  - aluminium crossbars with fixing parts and rubber profile
  - aluminium side rails
  - aluminium loading roller
  - fixing screws in stainless steel





## IMPERIAALS EN LADDERDRAGERS - ROOF AND LADDER RACK

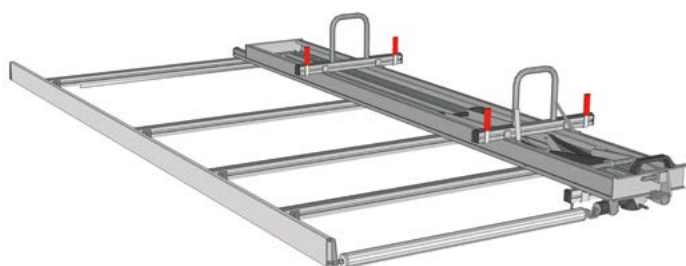

VOERTUIG VEHICLE	LADDERDRAGER LADDER RACK	AFMETINGEN DIMENSIONS	GEWICHT WEIGHT	DRAAGVERMOGEN LOAD CAPACITY
ART. NR. / ITEM NO.				
<b>Voertuigtype - Model</b> L1 H1 Kort, Normaal Dak Short, Standard Roof	<b>POS 107</b>	2750x1680 mm	58,78 kg	141,00 kg
<b>Voertuigtype - Model</b> L1 H2 Kort, Hoog Dak Short, High Roof	<b>POS 113</b>	2750x1680 mm	58,78 kg	91,00 kg
<b>Voertuigtype - Model</b> L2 H1 Middellang, Normaal Dak Medium, Standard Roof	<b>POS 108</b>	3400x1680 mm	62,89 kg	137,00 kg
<b>Voertuigtype - Model</b> L2 H2 Middellang, Hoog Dak Medium, High Roof	<b>POS 109</b>	3400x1680 mm	62,89 kg	87,00 kg
<b>Voertuigtype - Model</b> L3 H2 Lang, Hoog Dak Long, High Roof	<b>POS 110</b>	4350x1680 mm	68,55 kg	81,00 kg
<b>Voertuigtype - Model</b> L3L H2 Extralang, Hoog Dak Extra-long, High Roof	<b>POS 111</b>	4700x1680 mm	73,10 kg	77,00 kg

## POS

- Ladderdrager bestaande uit:
  - Alu-dwarsdragers inclusief bevestigingen en rubber profielen
  - Aluminium zijkanten
  - Aluminium laadrol
  - Ladderrail uit aluminium en RVS
  - RVS bevestigingsmateriaal
- Ladder rack complete of:
  - aluminium crossbars with fixing parts and rubber profile
  - aluminium side rail
  - aluminium loading roller
  - ladder rack rail made of aluminium and stainless steel
  - fixing screws in stainless steel

- De ladderdrager kan links of rechts worden gemonteerd.
- The ladder rack rail can be mounted on the right or left side.

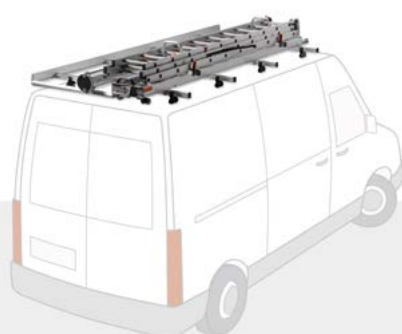



ART. NR. / ITEM NO. ACS 005

- Papierrollen-Kit Ø 140 mm
- Paper roll holder Ø 140 mm



ART. NR. / ITEM NO. ACS 012

- Papierrollen-Kit Ø 240 mm
- Paper roll holder Ø 240 mm



ART. NR. / ITEM NO. ACS 013

- Kitpatroonhouder
- Silicone holder kit



ART. NR. / ITEM NO. ACS 014

- Slangenhaspel
- Cable holder



ART. NR. / ITEM NO. ACS 004

- EHBO trommel
- First aid kit



ART. NR. / ITEM NO. ACS 006

- Documentenhouder DIN A4
- DIN A4 pocket document holder



ART. NR. / ITEM NO. ACS 007

- Spuitbus- of kitpatroonhouder
- Spray can holder



ART. NR. / ITEM NO. ACS 015

- Houder met 1 container grootte 1PL
- Holder with 1 container mesure 1 PL



ART. NR. / ITEM NO. ACS 016

- Houder met 3 containers grootte 1PL
- Holder with 3 containers mesure 1 PL



ART. NR. / ITEM NO. ACS 017

- Houder met container grootte 2115A
- Holder with box mesure 2115A



ART. NR. / ITEM NO. ACS 001

- Handenwas-kit
- Hand wash kit



ART. NR. / ITEM NO. ACS 002

- Jerrycan houder met stalen jerrycan Inh. 20 Lt.
- Jerrycan holder with 20 litres iron jerrycan

## ACCESSOIRES - ACCESSORIES

**ART. NR. / ITEM NO. ACS 003**
**A**

- Houder met sjarband voor flessen en brandblusser
- Holder with belt for gas cylinders and extinguishers

**ART. NR. / ITEM NO. ACS 018**
**B**

- Brandblusser 4 kg
- Fire extinguisher 4 kg

**ART. NR. / ITEM NO. ACS 019**
**C**

- All Safe Bar L=365 mm met sjarband en ratel
- All Safe bar L= 365 mm and ratchet belt

**ART. NR. / ITEM NO. ACS 020**
**C**

- All Safe Bar L=445 mm met sjarband en ratel
- All Safe bar L= 445 mm and ratchet belt

**ART. NR. / ITEM NO. ACS 021**
**D**

- All Safe Bar L=365 mm met sjarband en snapsluiting
- All Safe bar L= 365 mm and clamp belt

**ART. NR. / ITEM NO. ACS 022**
**D**

- All Safe Bar L=445 mm met sjarband en snapsluiting
- All Safe bar L= 445 mm and clamp belt

 Voorbeeld met 2 **ART. NR. ACS 003**  
 Example with 2 **ITEMS NO. ACS 003**

 Voorbeeld met 2 **ART. NR. ACS 019**  
 Example with 2 **ITEMS NO. ACS 019**

 Voorbeeld met 2 **ART. NR. ACS 021**  
 Example with 2 **ITEMS NO. ACS 021**

**ART. NR. / ITEM NO. ACS 023**

- Set 10 magneten Ø 20 mm
- Set of 10 magnets Ø 20 mm

**ART. NR. / ITEM NO. ACS 024**

- Set 10 magneten Ø 25 mm
- Set of 10 magnets Ø 25 mm

**ART. NR. / ITEM NO. ACS 025**

- LED-Lamp L=600 mm IP20 12V
- LED lamp L=600 mm IP20 12V

#### LEVERVOORWAARDEN

- Bodemplaten en wandbekledingen worden in meerdere delen geleverd.
- Bodemplaten, wandbekledingen, imperiaals. Ladderdragers worden in **onderdelen** geleverd.
- Modulen worden **geprefabriceerd**, compleet met bevestigingsmaterialen geleverd.
- Producten dienen bij voorkeur door daartoe **aangewezen dealers** te worden gemonteerd.
- Producten worden **verpakt** aangeleverd.
- **3 jaar garantie** op onze componenten.
- De genoemde draagvermogens hebben betrekking op **gelijkmatig verdeelde last**.

#### SUPPLY CONDITIONS

- Flooring and linings supplied in several pieces.
- Roof and ladder racks supplied **flat-packed**.
- Modules are supplied **preassembled** complete of fixing material to the vehicle.
- For products installation, please get in touch with our **approved installer's network**.
- Products provided **with packaging**.
- Our products are covered by a **3-years warranty**.
- Load capacities refer to **uniformly distributed loads**.

[www.STOREVAN.vlaanderen](http://www.STOREVAN.vlaanderen)

#### Uw contacten, onze steunpunten:

**Storevan Vlaanderen**  
Peter Engels  
contact@storevan.vlaanderen  
+32 (0) 477 70 88 88

**Carrosseriebouw Desmet**  
Houtekietstraat 16  
8540 Deerlijk  
didier@carrosseriebouw-desmet.be  
+32 (0) 56 77 55 21

**Carrosserie Van Wiemeersch**  
Industrieweg 152-154  
9030 Gent  
luc@vanwiemeersch.com  
+32 (0) 9 227 49 50

**Dias nv**  
Bettestraat 6  
9190 Stekene  
info@dias-firetrucks.be  
+32 (0) 3 779 70 90

**Thomas Alfons bvba**  
Brusselsesteenweg 130  
1785 Merchtem  
luc@thomasalfons.be  
+32 (0) 52 37 05 11

