



**BEDRIJFSWAGEN-
INRICHTINGEN**

**FITTINGS FOR
COMMERCIAL VEHICLES**



PEUGEOT PARTNER



STOREVAN ORANGE PLANET - STOREVAN ORANGE PLANET

**STOREVAN ORANGE PLANET**

Duurzaamheid en ecologische ontwikkelingen zijn thema's van groot, actueel belang, ontstaan door het toenemende bewustzijn, dat het milieu door cyclische veranderingen en vernieuwingen in balans moet blijven.

STOREVAN ORANGE PLANET

Environmental sustainability and eco-compatible development are topics of great interest and relevance, arising from the growing awareness that it is important to pay attention to the environmental balance.

CERTIFICERINGEN - CERTIFICATIONS

GECERTIFICEERDE PRODUCTIE

- ISO 9001:2008 zertifiziert.
- Succesvolle CRASH TEST volgens ECE-R17 met een snelheid van 50 Km/h.
- GS-Certificaat voor de laadplatforms en inrichtingen.
- GS-Certificaat voor imperiaal en ladderdrager.

CERTIFIED PRODUCTION

- ISO 9001:2008 certified.
- Brilliantly passed the CRASH TEST carried out according to the most recent European regulations ECE-R17 with impact at 50 Km/h.
- GS certification for interior fittings and loading ramps.
- GS certification for roof and ladder racks.



CRASH TEST
ECE-R17



StoreVan is wereldwijd de enige fabrikant van bedrijfswageninrichtingen, die met deze technologie werkt.

StoreVan is the sole LCV's equipment manufacturer worldwide to make use of this technology.



GEGALVANISEERD STAAL

Het product wordt onder verhitting tot ca. 550 °C voorzien van een zinklaag. Daardoor ontstaat er een legering tussen blik en zink. Dat resulteert in een laag met een evenwichtige, fijne kristalstructuur en een **zeer hoge oppervlakte kwaliteit en corrosiebestendigheid**. Dit procedé is ideaal voor automotieve toepassingen. StoreVan heeft deze techniek nu ook voor haar bedrijfswageninrichtingen geïmplementeerd.

HET PROCES VAN HET KATHODISCHE ACRYL DOMPELBAD VERFSYSTEEM

De kathodische Acryl-afwerking is een oppervlakte behandeling, die de diverse onderdelen van de inrichting een **extrem hoge Corrosiebestendigheid** bezorgt. De dompelbad techniek garandeert een **gelijkmatige laagdikte** en een landurige bescherming tegen alle mogelijke stoffen. De Acrylhars beschermt de lak tegen uitbleken door weersinvloeden en is slagvast en daarmee blijvend corrosiebestendig.

- Corrosiebestendigheid meer dan 500 uur (ASTM D1735 Luchtvochtigheid)
- Uistekende hardheid met tenminste een rating van 2 H



GALVANNEALED STEEL

Galvannealed sheet is a variant of hot-dip galvanized sheet. The product is subject to a hot-dip-galvanization process and subsequently heated to approximately 550°C, combining the zinc with the sheet surface to make an alloy with iron. The result is a uniform zinc coating with a fine-grained crystalline structure along with a **much higher surface quality and corrosion resistance**. This process is ideal for automotive applications. StoreVan introduced and implemented this technology in the commercial vehicles equipment field.

CATHODIC DIP PAINTING WITH ACRYLIC RESIN

Cataphoresis painting is a paint surface treatment able to give the equipment elements a **remarkable resistance to corrosion**; characterized by **uniform deposit** of an acrylic resin on the element surface, it ensures long lasting and high protection against chemical agents and other types of surface attacks. The acrylic resin allows a direct exposure to atmospheric agents without altering its technical features. This process ensures an increased protection against rust.

- Corrosion resistance of more than 500 hours (humidity ASTM D1735)
- Excellent hardness with a minimum rating of 2H





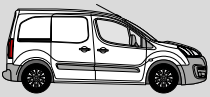

PEUGEOT PARTNER

BESTELWAGEN - PANEL VAN

BODEM- EN ZIJWANDBEKLEDING - FLOORING AND LININGS

- Bodemplaat en zijwandbekledingen voor een voertuig met rechter schuifdeur en stalen zijwanden.
- Flooring and linings for right side door vehicle with metal sheet sidewalls.

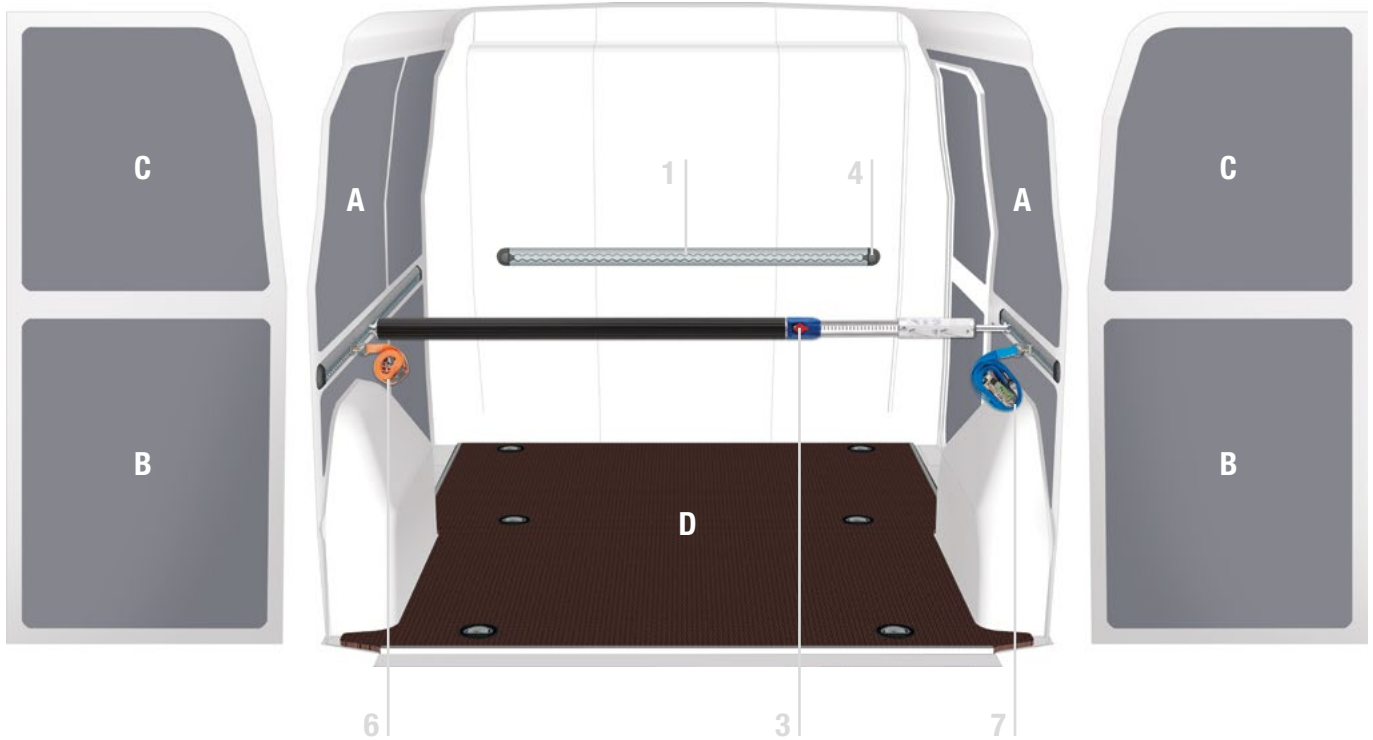

VOERTUIG VEHICLE	BODEMPLAAT 12 mm 12 mm FLOORING	WANDBEKLEDING LINING	WANDBEKLEDING LINING
	D	A+B	C
	ART. NR. / ITEM NO.	ART. NR. / ITEM NO.	ART. NR. / ITEM NO.
Voertuigtype - Model L1	PIL 011 17,65 kg	PAN 020 3,58 kg	PAR 007 1,02 kg
Voertuigtype - Model L2	PIL 012 20,20 kg	PAN 021 4,92 kg	PAR 007 1,02 kg

BODEM- EN ZIJWANDBEKLEDING - FLOORING AND LININGS



PAN

- Wandbekleding uit polypropyleen voor:
 - linker zijwand
 - rechter zijwand en schuifdeur
- Polypropylene linings for:
 - LH sidewall
 - RH sidewall and sliding door

PAR

- Wandbekleding uit polypropyleen voor:
 - bovenste gedeelte van de achterdeuren
- Polypropylene linings for:
 - upper part of rear hinged doors



PIL

- Bodemplaat uit multiplex met fenolbekleding, dikte 12 mm, voorgeboord voor bevestiging met de bestaande sjoorgen.
- 12 mm thick wooden flooring with phenolic coating set for the vehicles original anchoring system

LADING BEVESTIGING - LOAD SECURING



BESCHRIJVING - DESCRIPTION

- Horizontale Alurail.
- Horizontal aluminium bar.

ALURAIL - BAR	1	LENGTE - LENGTH
ART. NR. / ITEM NO. F 22 FC V18029 05 00		500 mm
ART. NR. / ITEM NO. F 22 FC V18029 10 00		1000 mm
ART. NR. / ITEM NO. F 22 FC V18029 15 00		1500 mm
ART. NR. / ITEM NO. F 22 FC V18029 20 00		2000 mm
ART. NR. / ITEM NO. F 22 FC V18029 25 00		2500 mm



BESCHRIJVING - DESCRIPTION

- Horizontale Alurails voor zijwanden.
- Horizontal aluminium bar for side panels.

ALURAIL - BAR	2	LENGTE - LENGTH
ART. NR. / ITEM NO. F 22 FC V18025 05 00		500 mm
ART. NR. / ITEM NO. F 22 FC V18025 10 00		1000 mm
ART. NR. / ITEM NO. F 22 FC V18025 15 00		1500 mm



BESCHRIJVING - DESCRIPTION

- Telescopische spanstang.
- Telescopic load restraining bar.

STANGEN - BAR	3	HOOGTE - HEIGHT
ART. NR. / ITEM NO. F 22 FC V22149 00 00		650-900 mm
ART. NR. / ITEM NO. F 22 FC V22131 00 00		1250-1750 mm
ART. NR. / ITEM NO. F 22 FC V22017 00 00		1550-2050 mm



BESCHRIJVING - DESCRIPTION

- Eindstop uit voor Alurail Serie V18029.
- Plastic end cap for bar series V18029.

EINDSTOP VOOR ALURAIL - PLASTIC END CAP FOR BAR	4
ART. NR. / ITEM NO. F 22 FC V22106 00 00	



BESCHRIJVING - DESCRIPTION

- Trekoog.
- Ring stud fitting.

TREKOOG - RING STUD FITTING	5
ART. NR. / ITEM NO. F 22 FC V22090 00 00	



BESCHRIJVING - DESCRIPTION

- Sjoorband met snapsluiting 2500+500.
- Load restraining belt with clamp 2500+500.

SJOORBAND - BELT	6
ART. NR. / ITEM NO. F 22 FC V22136 00 00	



BESCHRIJVING - DESCRIPTION

- Sjoorband met ratel 2500+500.
- Load restraining belt with ratchet 2500+500.

SJOORBAND - BELT	7
ART. NR. / ITEM NO. F 22 FC V22124 00 00	

Voor verdere informatie kunt u onze catalogus "Load Securing" raadplegen

For more information, ask for our "Load Securing" catalogue



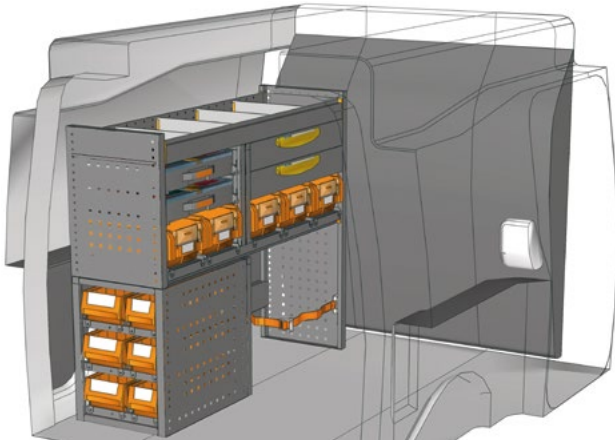
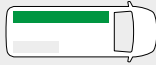

INRICHTINGSVOORBEELDEN - FITTINGS EXAMPLES

VOORBEELD - EXAMPLE
PA 1210 05*

B=1225 D=365 H=1000 mm - W=1225 D=365 H=1000 mm

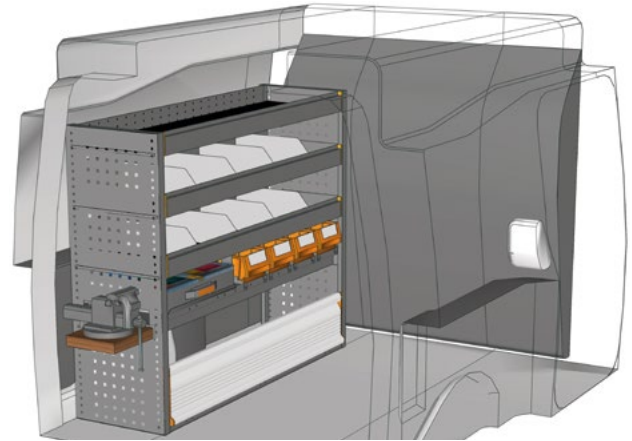
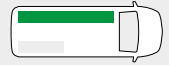
VOORBEELD - EXAMPLE
PA 1210 06*

B=1225 D=365 H=1000 mm - W=1225 D=365 H=1000 mm

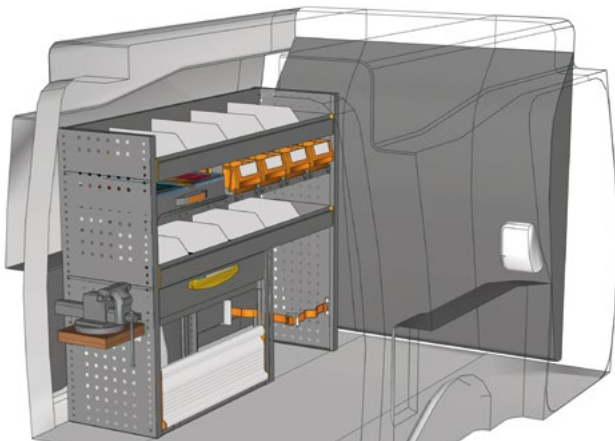
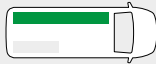
VOORBEELD - EXAMPLE
PA 1210 07*

B=1225 D=365 H=1000 mm - W=1225 D=365 H=1000 mm

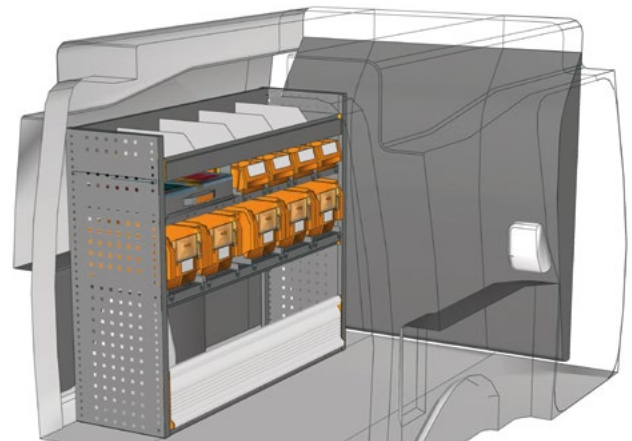
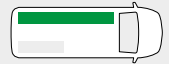
VOORBEELD - EXAMPLE
PA 1210 08*

B=1225 D=365 H=1000 mm - W=1225 D=365 H=1000 mm

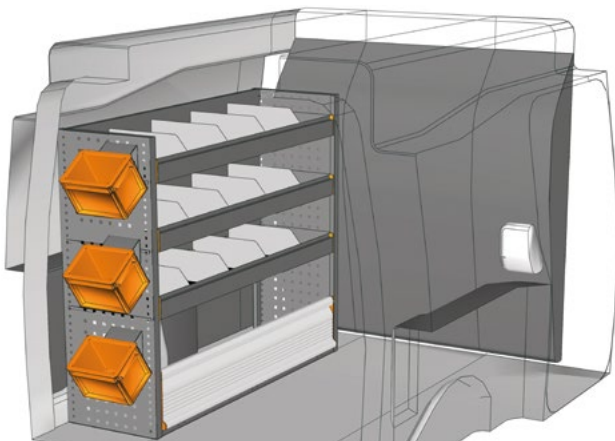
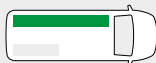
VOORBEELD - EXAMPLE
PA 1210 09*

B=1225 D=365 H=1000 mm - W=1225 D=365 H=1000 mm

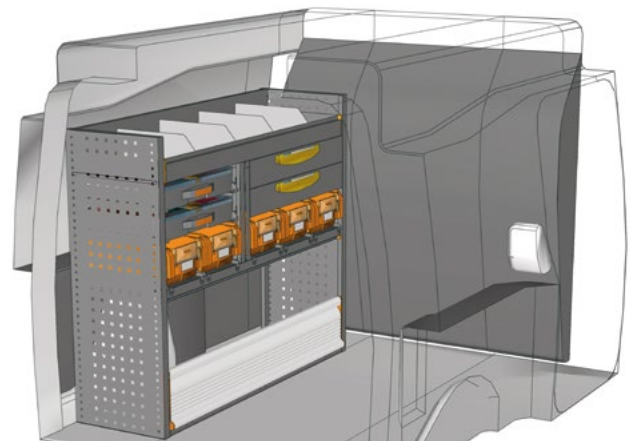
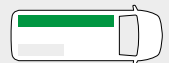
VOORBEELD - EXAMPLE
PA 1210 10*

B=1225 D=365 H=1000 mm - W=1225 D=365 H=1000 mm



INRICHTINGSVOORBEELDEN - FITTINGS EXAMPLES

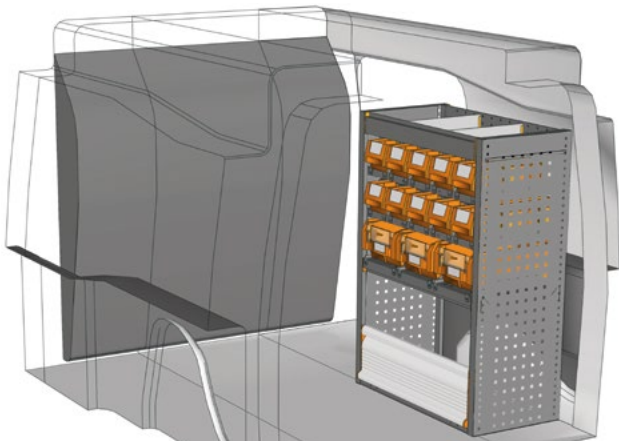

VOORBEELD - EXAMPLE

PA 0710 05*

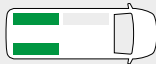

B=717 D=365 H=1000 mm - W=717 D=365 H=1000 mm

**Heeft u uw ideale inrichting niet gevonden?
Dan wendt u zich aan onze vakmensen voor
bedrijfswageninrichtingen.**

Op de achterzijde vindt u de
adresgegevens of bezoek onze
website www.storevannederland.nl



**Didn't find the equipment
you're looking for?
Leave it to our experts.**

See the back of this catalogue
and contact the nearest
StoreVan point or visit our website.

*** Inclusief bevestigingsmateriaal - Fixing kit included**

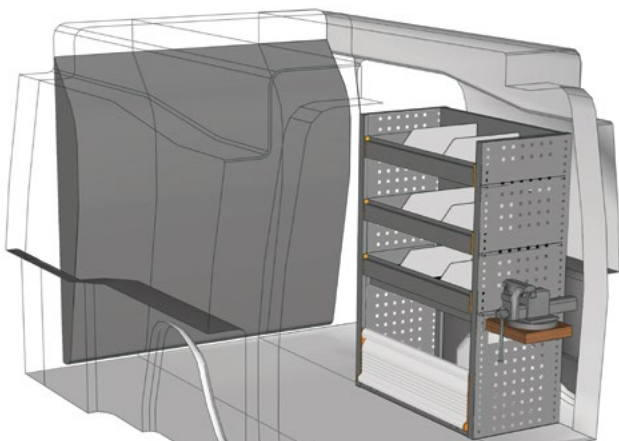

VOORBEELD - EXAMPLE

PA 0710 06*

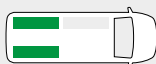

B=717 D=365 H=1000 mm - W=717 D=365 H=1000 mm

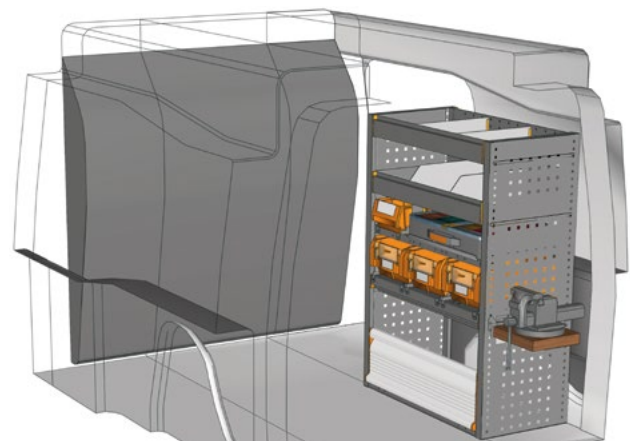

VOORBEELD - EXAMPLE

PA 0710 07*

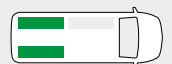

B=717 D=365 H=1000 mm - W=717 D=365 H=1000 mm

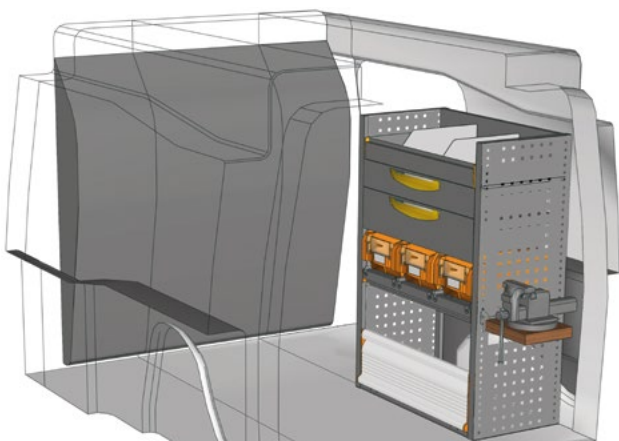

VOORBEELD - EXAMPLE

PA 0710 08*

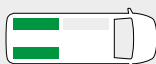

B=717 D=365 H=1000 mm - W=717 D=365 H=1000 mm

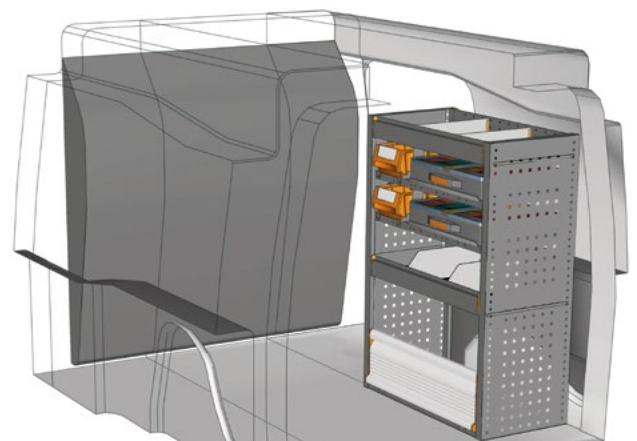

VOORBEELD - EXAMPLE

PA 0710 09*

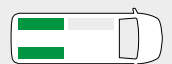

B=717 D=365 H=1000 mm - W=717 D=365 H=1000 mm

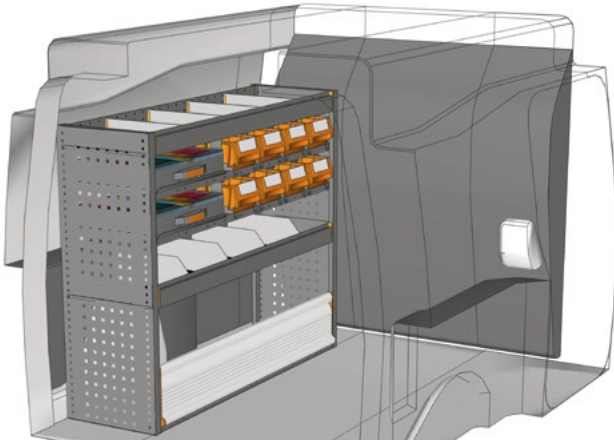
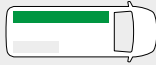

INRICHTINGSVOORBEELDEN - FITTINGS EXAMPLES

VOORBEELD - EXAMPLE
PA 1210 11*

B=1225 D=365 H=1000 mm - W=1225 D=365 H=1000 mm

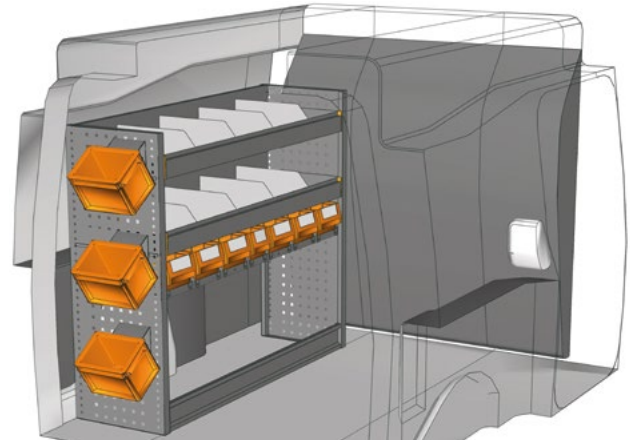
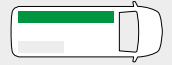
VOORBEELD - EXAMPLE
PA 1210 12*

B=1225 D=365 H=1000 mm - W=1225 D=365 H=1000 mm

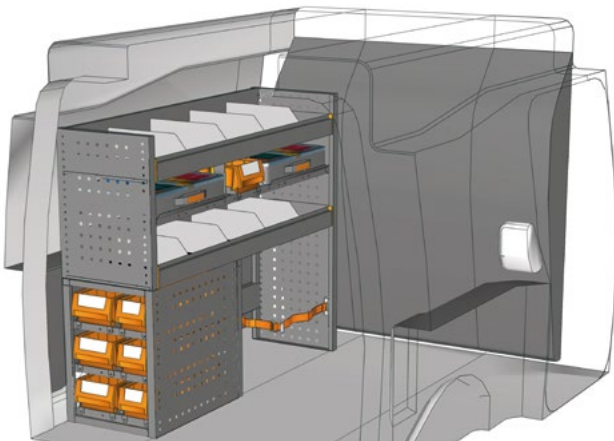
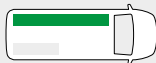
VOORBEELD - EXAMPLE
PA 1210 13*

B=1225 D=365 H=1000 mm - W=1225 D=365 H=1000 mm

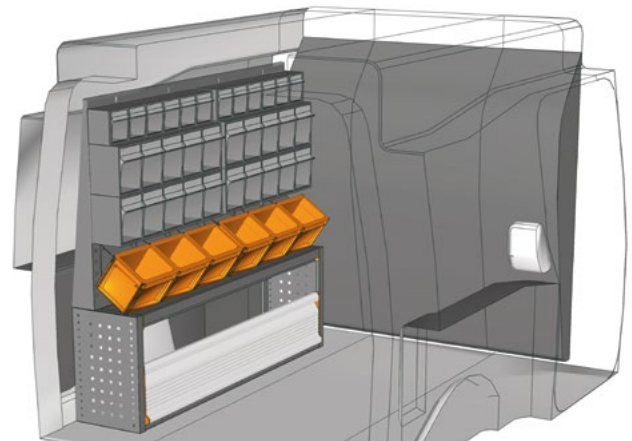
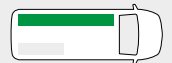
VOORBEELD - EXAMPLE
PA 1211 04*

B=1225 D=265 H=1100 mm - W=1225 D=265 H=1100 mm

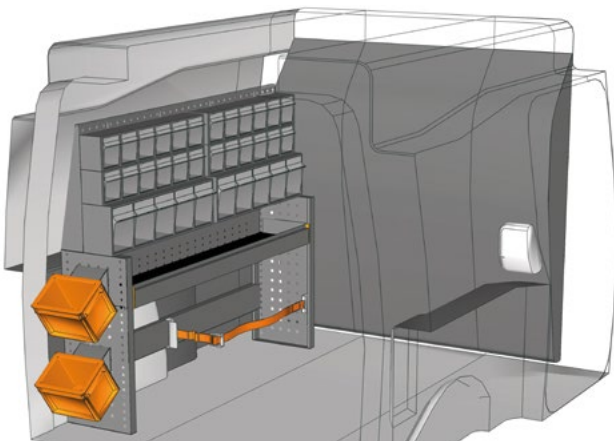
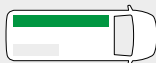
VOORBEELD - EXAMPLE
PA 1211 05*

B=1225 D=265 H=1020 mm - W=1225 D=265 H=1020 mm

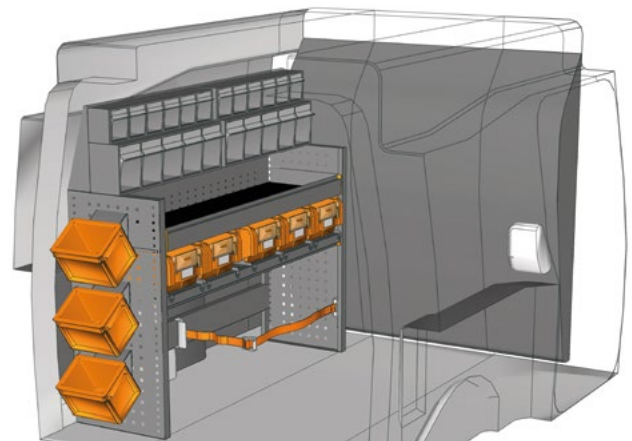
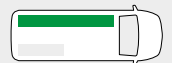
VOORBEELD - EXAMPLE
PA 1211 06*

B=1225 D=365 H=1080 mm - W=1225 D=365 H=1080 mm



INRICHTINGSVOORBEELDEN - FITTINGS EXAMPLES

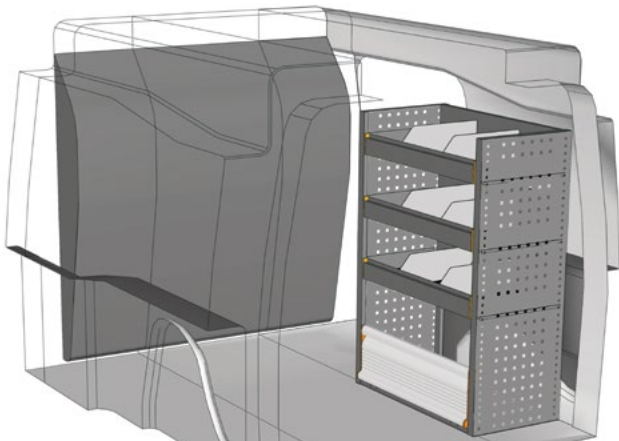

VOORBEELD - EXAMPLE

PA 0710 10*

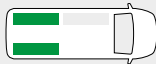

B=717 D=365 H=1000 mm - W=717 D=365 H=1000 mm

**Heeft u uw ideale inrichting niet gevonden?
Dan wendt u zich aan onze vakmensen voor
bedrijfswageninrichtingen.**

Op de achterzijde vindt u de
adresgegevens of bezoek onze
website www.storevannederland.nl



**Didn't find the equipment
you're looking for?
Leave it to our experts.**

See the back of this catalogue
and contact the nearest
StoreVan point or visit our website.

*** Inclusief bevestigingsmateriaal - Fixing kit included**

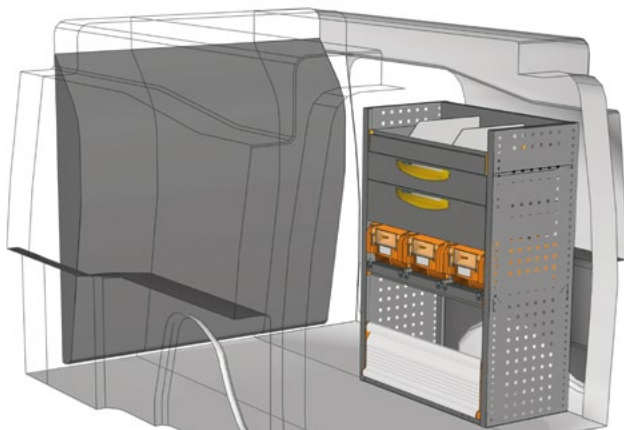

VOORBEELD - EXAMPLE

PA 0710 11*

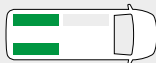

B=717 D=365 H=1000 mm - W=717 D=365 H=1000 mm

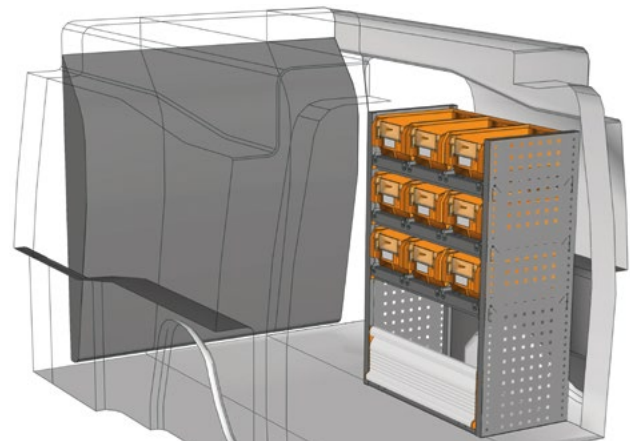

VOORBEELD - EXAMPLE

PA 0710 12*



B=717 D=365 H=1000 mm - W=717 D=365 H=1000 mm

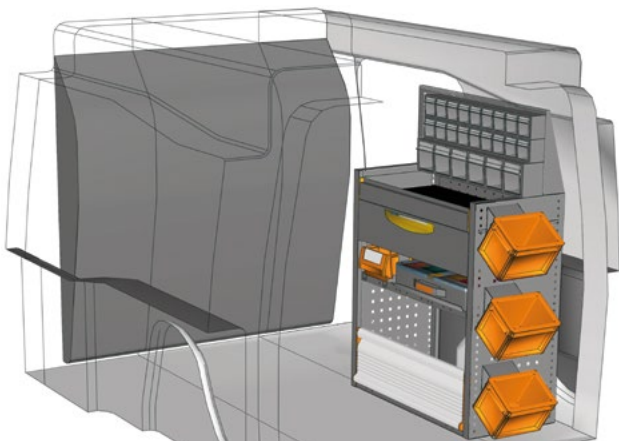

VOORBEELD - EXAMPLE

PA 0711 03*

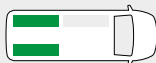

B=717 D=365 H=1080 mm - W=717 D=365 H=1080 mm

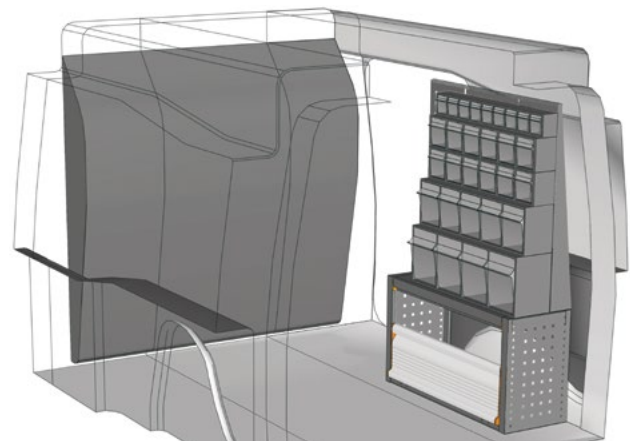

VOORBEELD - EXAMPLE

PA 0711 04*



B=717 D=265 H=1100 mm - W=717 D=265 H=1100 mm

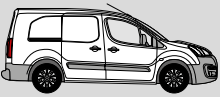

INRICHTINGSVOORBEELDEN - FITTINGS EXAMPLES

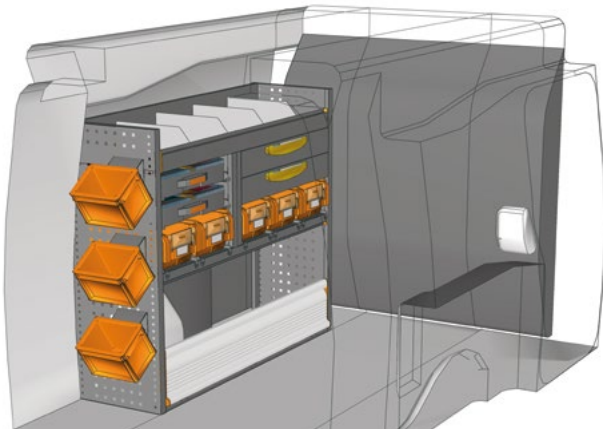
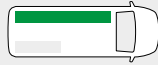
VOORBEELD - EXAMPLE
PA 1210 01*

B=1225 D=365 H=1000 mm - W=1225 D=365 H=1000 mm

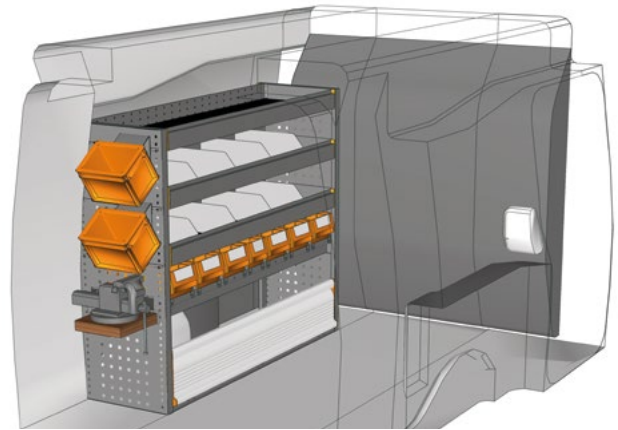
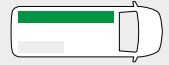
VOORBEELD - EXAMPLE
PA 1210 02*

B=1225 D=365 H=1000 mm - W=1225 D=365 H=1000 mm

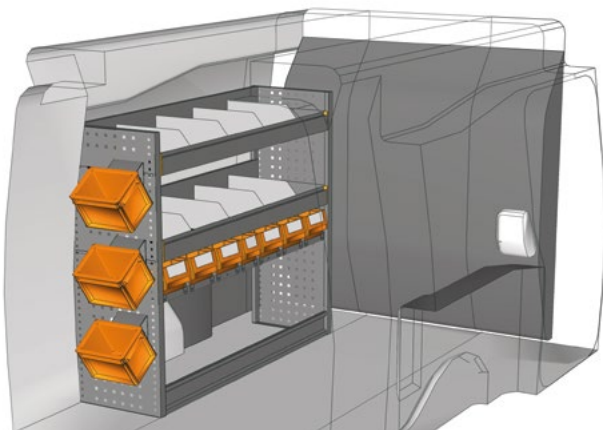
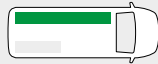
VOORBEELD - EXAMPLE
PA 1210 03*

B=1225 D=365 H=1000 mm - W=1225 D=365 H=1000 mm

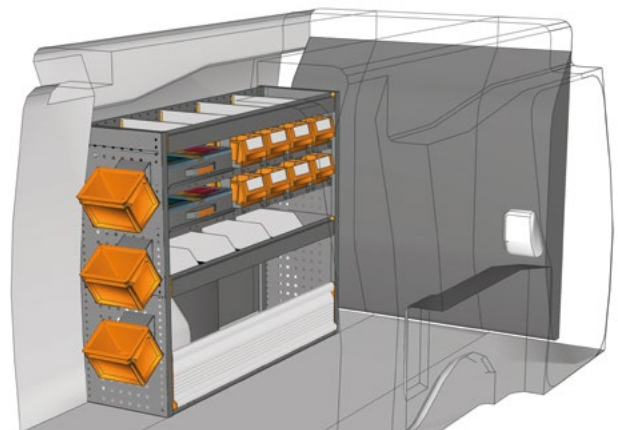
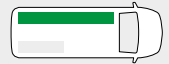
VOORBEELD - EXAMPLE
PA 1210 04*

B=1225 D=365 H=1000 mm - W=1225 D=365 H=1000 mm

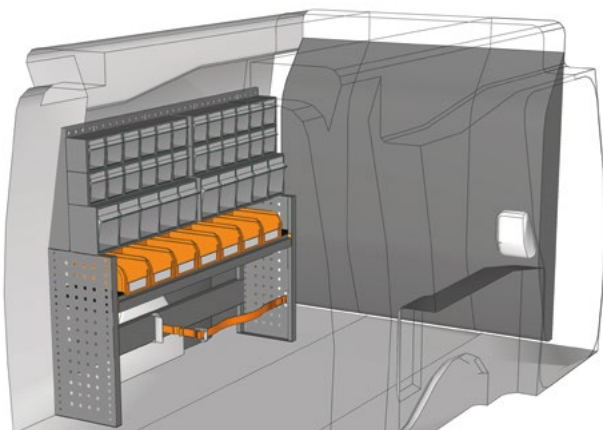
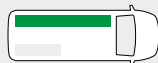
VOORBEELD - EXAMPLE
PA 1211 02*

B=1225 D=265 H=1020 mm - W=1225 D=265 H=1020 mm

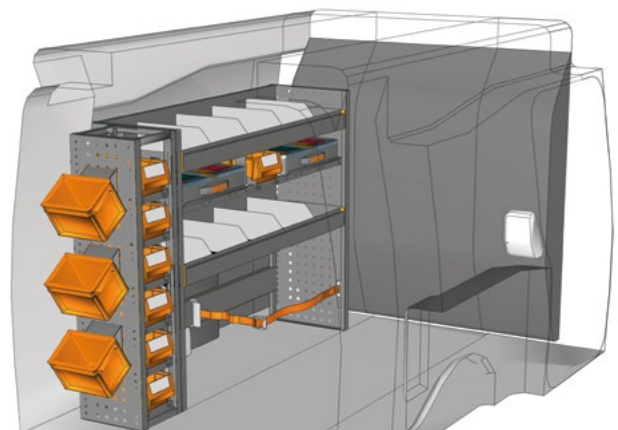
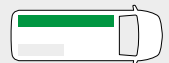
VOORBEELD - EXAMPLE
PA 1410 01*

B=1460 D=365 H=1000 mm - W=1460 D=365 H=1000 mm



INRICHTINGSVOORBEELDEN - FITTINGS EXAMPLES

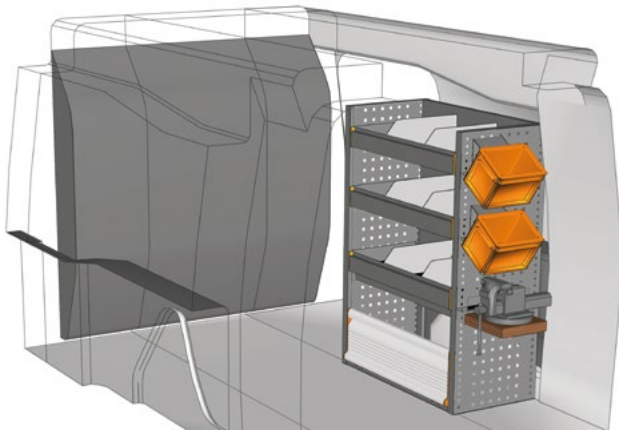

VOORBEELD - EXAMPLE

PA 0710 01*

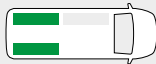

B=717 D=365 H=1000 mm - W=717 D=365 H=1000 mm

**Heeft u uw ideale inrichting niet gevonden?
Dan wendt u zich aan onze vakmensen voor
bedrijfswageninrichtingen.**

Op de achterzijde vindt u de
adresgegevens of bezoek onze
website www.storevannederland.nl



**Didn't find the equipment
you're looking for?
Leave it to our experts.**

See the back of this catalogue
and contact the nearest
StoreVan point or visit our website.

*** Inclusief bevestigingsmateriaal - Fixing kit included**

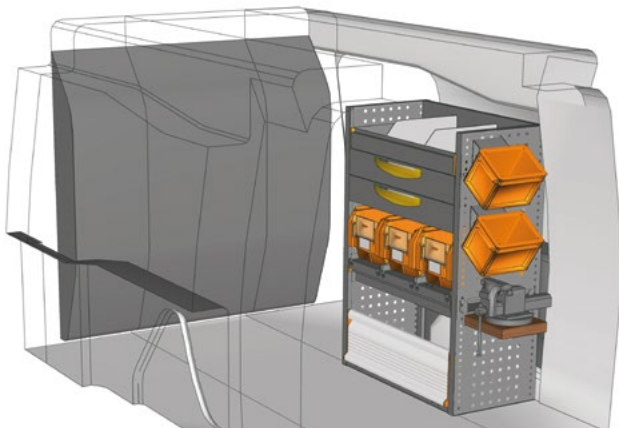

VOORBEELD - EXAMPLE

PA 0710 02*

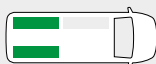

B=717 D=365 H=1000 mm - W=717 D=365 H=1000 mm

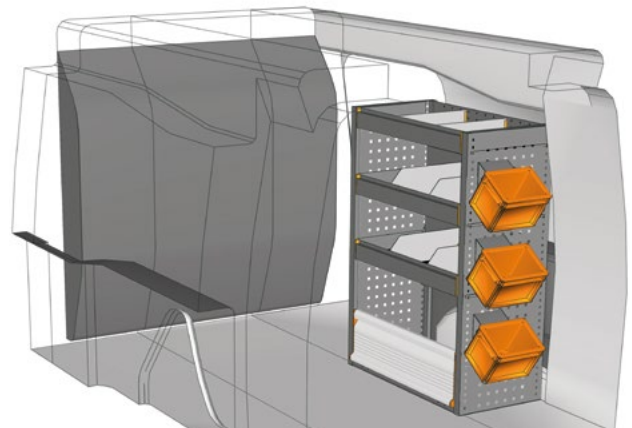

VOORBEELD - EXAMPLE

PA 0710 04*

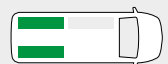

B=717 D=365 H=1000 mm - W=717 D=365 H=1000 mm

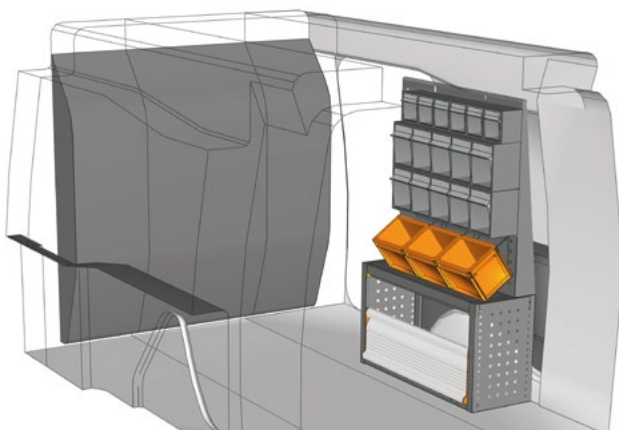

VOORBEELD - EXAMPLE

PA 0711 01*

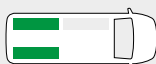

B=717 D=365 H=1100 mm - W=717 D=365 H=1100 mm

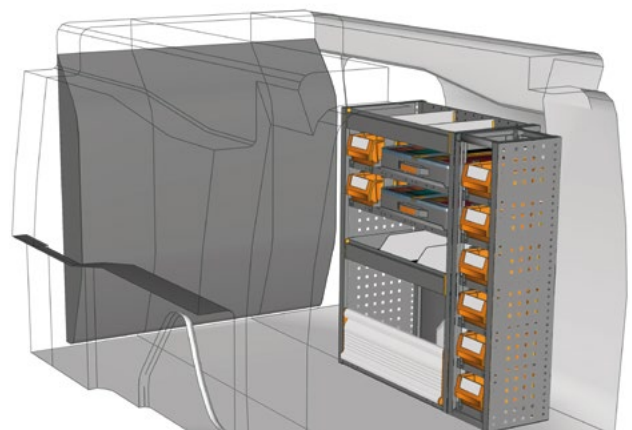

VOORBEELD - EXAMPLE

PA 0910 01*

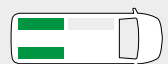

B=952 D=365 H=1000 mm - W=952 D=365 H=1000 mm



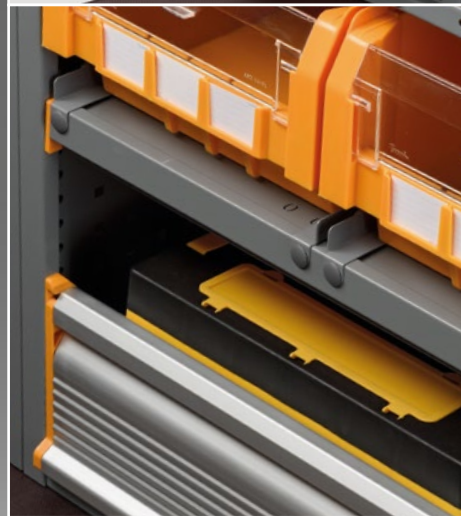



PEUGEOT PARTNER

BESTELWAGEN - PANEL VAN



IMPERIAALS EN LADDERDRAGERS - ROOF AND LADDER RACK



VOERTUIG VEHICLE	IMPERIAAL ROOF RACK	AFMETINGEN DIMENSIONS	GEWICHT WEIGHT	DRAAGVERMOGEN LOAD CAPACITY
	ART. NR. / ITEM NO.			
Voertuigtype - Model L1	POT 011	2000x1400 mm	22,00 kg	77,00 kg
Voertuigtype - Model L2	POT 012	2500x1400 mm	23,92 kg	75,00 kg

- Alleen voor voertuigen met achterdeuren.
- Only for vehicle with rear leaf doors.

POT

- Imperiaal bestaande uit:
 - Alu-dwarsdragers inclusief bevestigingen en rubber profielen
 - Aluminium zijkanten
 - Aluminium laadrol
 - RVS bevestigingsmateriaal
- Roof rack complete of:
 - aluminium crossbars with fixing parts and rubber profile
 - aluminium side rails
 - aluminium loading roller
 - fixing screws in stainless steel

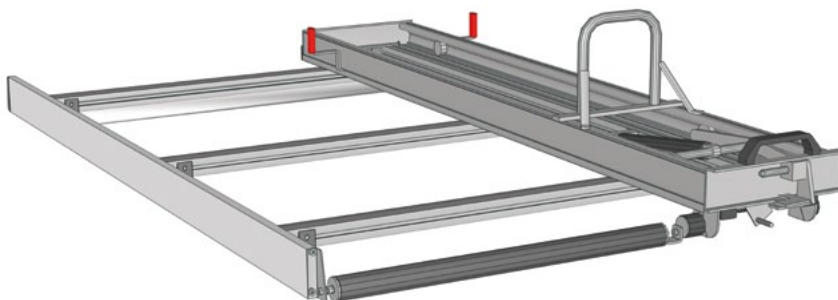

VOERTUIG VEHICLE	LADDERDRAGER LADDER RACK	AFMETINGEN DIMENSIONS	GEWICHT WEIGHT	DRAAGVERMOGEN LOAD CAPACITY
	ART. NR. / ITEM NO.			
Voertuigtype - Model L1	POS 013	2110x1380 mm	43,55 kg	56,00 kg
Voertuigtype - Model L2	POS 014	2650x1380 mm	48,74 kg	51,00 kg

- Alleen voor voertuigen met achterdeuren. De ladderdrager kan links of rechts worden gemonteerd.
- Only for vehicle with rear leaf doors. The ladder rack rail can be mounted on the right or left side.

POS

- Ladderdrager bestaande uit:
 - Alu-dwarsdragers inclusief bevestigingen en rubber profielen
 - Aluminium zijkanten
 - Aluminium laadrol
 - Ladderrail uit aluminium en RVS
 - RVS bevestigingsmateriaal
- Ladder rack complete of:
 - aluminium crossbars with fixing parts and rubber profile
 - aluminium side rail
 - aluminium loading roller
 - ladder rack rail made of aluminium and stainless steel
 - fixing screws in stainless steel



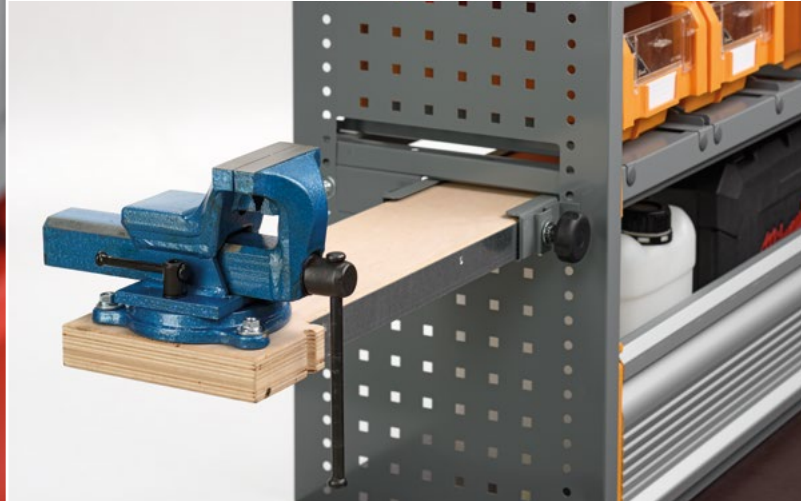



ART. NR. / ITEM NO. ACS 005

- Papierrollen-Kit Ø 140 mm
- Paper roll holder Ø 140 mm



ART. NR. / ITEM NO. ACS 012

- Papierrollen-Kit Ø 240 mm
- Paper roll holder Ø 240 mm



ART. NR. / ITEM NO. ACS 013

- Kitpatroonhouder
- Silicone holder kit



ART. NR. / ITEM NO. ACS 014

- Slangenhaspel
- Cable holder



ART. NR. / ITEM NO. ACS 004

- EHBO trommel
- First aid kit



ART. NR. / ITEM NO. ACS 006

- Documentenhouder DIN A4
- DIN A4 pocket document holder



ART. NR. / ITEM NO. ACS 007

- Spuitbus- of kitpatroonhouder
- Spray can holder



ART. NR. / ITEM NO. ACS 015

- Houder met 1 container grootte 1PL
- Holder with 1 container mesure 1 PL



ART. NR. / ITEM NO. ACS 016

- Houder met 3 containers grootte 1PL
- Holder with 3 containers mesure 1 PL



ART. NR. / ITEM NO. ACS 017

- Houder met container grootte 2115A
- Holder with box mesure 2115A



ART. NR. / ITEM NO. ACS 001

- Handenwas-kit
- Hand wash kit



ART. NR. / ITEM NO. ACS 002

- Jerrycan houder met stalen jerrycan Inh. 20 Lt.
- Jerrycan holder with 20 litres iron jerrycan

ACCESSOIRES - ACCESSORIES

ART. NR. / ITEM NO. ACS 003
A

- Houder met sjarband voor flessen en brandblusser
- Holder with belt for gas cylinders and extinguishers

ART. NR. / ITEM NO. ACS 018
B

- Brandblusser 4 kg
- Fire extinguisher 4 kg

ART. NR. / ITEM NO. ACS 019
C

- All Safe Bar L=365 mm met sjarband en ratel
- All Safe bar L= 365 mm and ratchet belt

ART. NR. / ITEM NO. ACS 020
C

- All Safe Bar L=445 mm met sjarband en ratel
- All Safe bar L= 445 mm and ratchet belt

ART. NR. / ITEM NO. ACS 021
D

- All Safe Bar L=365 mm met sjarband en snapsluiting
- All Safe bar L= 365 mm and clamp belt

ART. NR. / ITEM NO. ACS 022
D

- All Safe Bar L=445 mm met sjarband en snapsluiting
- All Safe bar L= 445 mm and clamp belt

 Voorbeeld met 2 **ART. NR. ACS 003**
 Example with 2 **ITEMS NO. ACS 003**

 Voorbeeld met 2 **ART. NR. ACS 019**
 Example with 2 **ITEMS NO. ACS 019**

 Voorbeeld met 2 **ART. NR. ACS 021**
 Example with 2 **ITEMS NO. ACS 021**

ART. NR. / ITEM NO. ACS 023

- Set 10 magneten Ø 20 mm
- Set of 10 magnets Ø 20 mm

ART. NR. / ITEM NO. ACS 024

- Set 10 magneten Ø 25 mm
- Set of 10 magnets Ø 25 mm

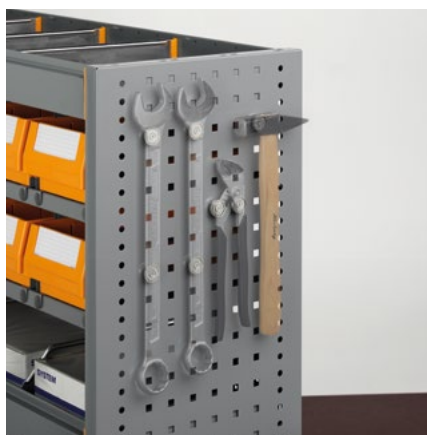
ART. NR. / ITEM NO. ACS 025

- LED-Lamp L=600 mm IP20 12V
- LED lamp L=600 mm IP20 12V

LIEFERBEDINGUNGEN

- Bodemplaten en wandbekledingen worden in meerdere delen geleverd.
- Bodemplaten, wandbekledingen, imperiaals. Ladderdragers worden in **onderdelen** geleverd.
- Modulen worden **geprefabriceerd**, compleet met bevestigingsmaterialen geleverd.
- Producten dienen bij voorkeur door daartoe **aangewezen dealers** te worden gemonteerd.
- Producten worden **verpakt** aangeleverd.
- **3 jaar garantie** op onze componenten.
- De genoemde draagvermogens hebben betrekking op **gelijkmatig verdeelde last**.

SUPPLY CONDITIONS

- Flooring and linings supplied in several pieces.
- Roof and ladder racks supplied **flat-packed**.
- Modules are supplied **preassembled** complete of fixing material to the vehicle.
- For products installation, please get in touch with our **approved installer's network**.
- Products provided **with packaging**.
- Our products are covered by a **3-years warranty**.
- Load capacities refer to **uniformly distributed loads**.

WWW.STOREVAN.COM



www.famisp.com | info@famisp.com
www.storevan.com | info@storevan.com

StoreVanNederland
Küster-Effort b.v.

Tel: 088 - 1301400
Fax: 088 - 1301499
info@storevannederland.nl
www.storevannederland.nl